

Guided Wave Radar

SITRANS LG240

4 ... 20 mA/HART - four-wire

PFA insulated

Operating Instructions • 09/2013



SITRANS

SIEMENS

Safety Guidelines: Warning notices must be observed to ensure personal safety as well as that of others, and to protect the product and the connected equipment. These warning notices are accompanied by a clarification of the level of caution to be observed.

Qualified Personnel: This device/system may only be set up and operated in conjunction with this manual. Qualified personnel are only authorized to install and operate this equipment in accordance with established safety practices and standards.

Unit Repair and Excluded Liability:

- The user is responsible for all changes and repairs made to the device by the user or the user’s agent.
- All new components are to be provided by Siemens Milltronics Process Instruments.
- Restrict repair to faulty components only.
- Do not reuse faulty components.

Warning: Cardboard shipping package provides limited humidity and moisture protection. This product can only function properly and safely if it is correctly transported, stored, installed, set up, operated, and maintained.

This product is intended for use in industrial areas. Operation of this equipment in a residential area may cause interference to several frequency based communications.

Note: Always use product in accordance with specifications.

| Copyright Siemens AG 2013. All Rights Reserved | Disclaimer of Liability |
|---|---|
| <p>This document is available in bound version and in electronic version. We encourage users to purchase authorized bound manuals, or to view electronic versions as designed and authored by Siemens Milltronics Process Instruments. Siemens Milltronics Process Instruments will not be responsible for the contents of partial or whole reproductions of either bound or electronic versions.</p> | <p>While we have verified the contents of this manual for agreement with the instrumentation described, variations remain possible. Thus we cannot guarantee full agreement. The contents of this manual are regularly reviewed and corrections are included in subsequent editions. We welcome all suggestions for improvement.</p> <p>Technical data subject to change.</p> |

MILLTRONICS® is a registered trademark of Siemens Milltronics Process Instruments.

Contact SMPI Technical Publications at the following address:

Technical Publications
 Siemens AG
 Siemens Milltronics Process Instruments
 1954 Technology Drive, P.O. Box 4225
 Peterborough, Ontario, Canada, K9J 7B1
 Email: techpubs.smpi@siemens.com

European Authorized Representative

Siemens AG
 Industry Sector
 76181 Karlsruhe
 Deutschland

- For a selection of Siemens Milltronics level measurement manuals, go to: **www.siemens.com/processautomation**. Under Process Instrumentation, select *Level Measurement* and then go to the manual archive listed under the product family.
- For a selection of Siemens Milltronics weighing manuals, go to: **www.siemens.com/processautomation**. Under Weighing Technology, select *Continuous Weighing Systems* and then go to the manual archive listed under the product family.

Contents

| | | |
|----------|--|----|
| 1 | About this document | |
| 1.1 | Function | 5 |
| 1.2 | Target group | 5 |
| 1.3 | Symbolism used | 5 |
| 2 | For your safety | |
| 2.1 | Authorised personnel | 6 |
| 2.2 | Appropriate use | 6 |
| 2.3 | Warning about incorrect use | 6 |
| 2.4 | General safety instructions | 6 |
| 2.5 | CE conformity | 6 |
| 2.6 | NAMUR recommendations | 7 |
| 2.7 | Environmental instructions | 7 |
| 3 | Product description | |
| 3.1 | Configuration | 8 |
| 3.2 | Principle of operation | 9 |
| 3.3 | Packaging, transport and storage | 11 |
| 3.4 | Accessories and replacement parts | 11 |
| 4 | Mounting | |
| 4.1 | General instructions | 13 |
| 4.2 | Mounting instructions | 13 |
| 5 | Connecting to power supply | |
| 5.1 | Preparing the connection | 18 |
| 5.2 | Connection | 19 |
| 5.3 | Wiring plan, double chamber housing | 20 |
| 5.4 | Supplementary electronics | 22 |
| 5.5 | Switch-on phase | 22 |
| 6 | Set up with the display and adjustment module | |
| 6.1 | Insert display and adjustment module | 24 |
| 6.2 | Adjustment system | 25 |
| 6.3 | Parameter adjustment - Quick setup | 26 |
| 6.4 | Parameter adjustment - Extended adjustment | 29 |
| 6.5 | Saving the parameter adjustment data | 47 |
| 7 | Setup with PACTware | |
| 7.1 | Connect the PC | 49 |
| 7.2 | Parameter adjustment with PACTware | 49 |
| 7.3 | Set up with the quick setup | 50 |
| 7.4 | Saving the parameter adjustment data | 55 |
| 8 | Set up with other systems | |
| 8.1 | DD adjustment programs | 56 |
| 8.2 | Field Communicator 375, 475 | 56 |
| 9 | Diagnostics and service | |
| 9.1 | Maintenance | 57 |
| 9.2 | Diagnosis memory | 57 |
| 9.3 | Status messages | 58 |
| 9.4 | Rectify faults | 61 |

| | | |
|-----------|--|----|
| 9.5 | Exchanging the electronics module..... | 64 |
| 9.6 | Software update | 64 |
| 9.7 | How to proceed in case of repair..... | 65 |
| 10 | Dismounting | |
| 10.1 | Dismounting steps..... | 66 |
| 10.2 | Disposal | 66 |
| 11 | Supplement | |
| 11.1 | Technical data | 67 |
| 11.2 | Dimensions | 75 |

Safety instructions for Ex areas



Please note the Ex-specific safety information for installation and operation in Ex areas. These safety instructions are part of the operating instructions manual and come with the Ex-approved instruments.

Editing status: 2013-09-09

1 About this document

1.1 Function

This operating instructions manual provides all the information you need for mounting, connection and setup as well as important instructions for maintenance and fault rectification. Please read this information before putting the instrument into operation and keep this manual accessible in the immediate vicinity of the device.

1.2 Target group

This operating instructions manual is directed to trained specialist personnel. The contents of this manual should be made available to these personnel and put into practice by them.

1.3 Symbolism used



Information, tip, note

This symbol indicates helpful additional information.



Caution: If this warning is ignored, faults or malfunctions can result.

Warning: If this warning is ignored, injury to persons and/or serious damage to the instrument can result.

Danger: If this warning is ignored, serious injury to persons and/or destruction of the instrument can result.



Ex applications

This symbol indicates special instructions for Ex applications.



List

The dot set in front indicates a list with no implied sequence.



Action

This arrow indicates a single action.



Sequence of actions

Numbers set in front indicate successive steps in a procedure.



Battery disposal

This symbol indicates special information about the disposal of batteries and accumulators.

2 For your safety

2.1 Authorised personnel

All operations described in this operating instructions manual must be carried out only by trained specialist personnel authorised by the plant operator.

During work on and with the device the required personal protective equipment must always be worn.

2.2 Appropriate use

SITRANS LG240 is a sensor for continuous level measurement.

You can find detailed information on the application range in chapter "*Product description*".

Operational reliability is ensured only if the instrument is properly used according to the specifications in the operating instructions manual as well as possible supplementary instructions.

2.3 Warning about incorrect use

Inappropriate or incorrect use of the instrument can give rise to application-specific hazards, e.g. vessel overfill or damage to system components through incorrect mounting or adjustment.

2.4 General safety instructions

This is a state-of-the-art instrument complying with all prevailing regulations and guidelines. The instrument must only be operated in a technically flawless and reliable condition. The operator is responsible for the trouble-free operation of the instrument.

During the entire duration of use, the user is obliged to determine the compliance of the necessary occupational safety measures with the current valid rules and regulations and also take note of new regulations.

The safety instructions in this operating instructions manual, the national installation standards as well as the valid safety regulations and accident prevention rules must be observed by the user.

For safety and warranty reasons, any invasive work on the device beyond that described in the operating instructions manual may be carried out only by personnel authorised by the manufacturer. Arbitrary conversions or modifications are explicitly forbidden.

The safety approval markings and safety tips on the device must also be observed.

2.5 CE conformity

The device fulfills the legal requirements of the applicable EC guidelines. By affixing the CE marking, we confirm successful testing of the product.

You can find the CE Certificate of Conformity in the download section of our homepage.

Electromagnetic compatibility

Instruments with plastic housing as well as in four-wire or Ex-d-ia version are designed for use in an industrial environment. Nevertheless, electromagnetic interference from electrical conductors and radiated emissions must be taken into account, as is usual with a class A instrument according to EN 61326-1. If the instrument is used in a different environment, the electromagnetic compatibility to other instruments must be ensured by suitable measures.

2.6 NAMUR recommendations

NAMUR is the automation technology user association in the process industry in Germany. The published NAMUR recommendations are accepted as the standard in field instrumentation.

The device fulfills the requirements of the following NAMUR recommendations:

- NE 21 – Electromagnetic compatibility of equipment
- NE 43 – Signal level for malfunction information from measuring transducers
- NE 53 – Compatibility of field devices and display/adjustment components
- NE 107 – Self-monitoring and diagnosis of field devices

For further information see www.namur.de.

2.7 Environmental instructions

Protection of the environment is one of our most important duties. That is why we have introduced an environment management system with the goal of continuously improving company environmental protection. The environment management system is certified according to DIN EN ISO 14001.

Please help us fulfill this obligation by observing the environmental instructions in this manual:

- Chapter "*Packaging, transport and storage*"
- Chapter "*Disposal*"

3 Product description

3.1 Configuration

Type plate

The nameplate contains the most important data for identification and use of the instrument:

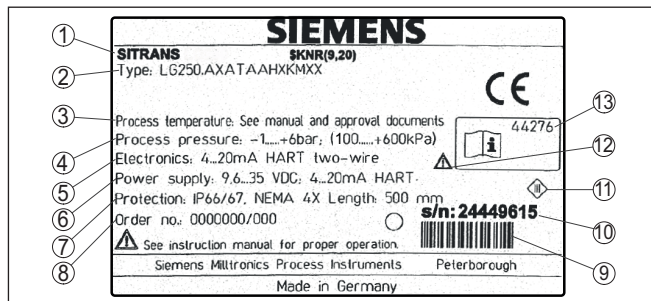

Fig. 2: Layout of the type label (example)

- 1 Instrument type
- 2 Product code
- 3 Process and ambient temperature, process pressure
- 4 Process pressure
- 5 Signal output electronics
- 6 Voltage supply
- 7 Protection rating
- 8 Order number
- 9 Identification code
- 10 Serial number of the instrument
- 11 Symbol of the device protection class
- 12 Reminder to observe the instrument documentation
- 13 ID numbers, instrument documentation

Scope of this operating instructions manual

This operating instructions manual applies to the following instrument versions:

- Hardware from 1.0.0
- Software from 1.0.0
- Only for instrument versions without SIL qualification

Versions

The instrument can be supplied in two different electronics versions. Each electronics version can be identified via the product code on the type label as well as on the electronics.

- Standard electronics with operating voltage 90 ... 253 V AC; 50/60 Hz: Typ FX80B.-
- Standard electronics with supply voltage 9.6 ... 48 V DC; 20 ... 42 V AC: Type FX80I.-

Scope of delivery

The scope of delivery encompasses:

- Sensor
- Documentation
 - this operating instructions manual
 - Test certificate measuring accuracy (optional)

- Operating instructions manual "*Display and adjustment module*" (optional)
- Supplementary instructions manual "*Plug connector for continuously measuring sensors*" (optional)
- Ex-specific "*Safety instructions*" (with Ex versions)
- if necessary, further certificates

3.2 Principle of operation

Application area

The SITRANS LG240 is a level sensor with coated cable or rod probe for continuous level or interface measurement, particularly suitable for applications in the chemical industry.

Functional principle - level measurement

High frequency microwave pulses are guided along a steel cable or a rod. Upon reaching the product surface, the microwave pulses are reflected. The running time is evaluated by the instrument and outputted as level.

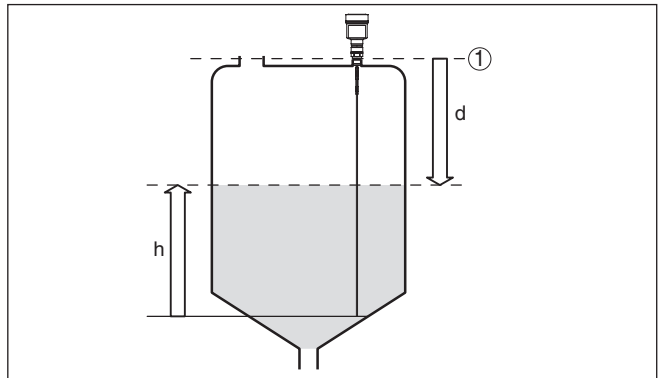

Fig. 3: Level measurement

- 1 Sensor reference plane (seal surface of the process fitting)
 d Distance to the interface (HART value 1)
 h Height - Level

Probe end tracking

To increase sensitivity, the probe is equipped with probe end tracking. In products with a low dielectric constant, this function is very helpful. This is the case, for example, in plastic granules, packing chips or in vessels with fluidized products.

Between a dielectric constant of 1.5 and 3, the function switches on, if required. As soon as the level echo can no longer be detected, probe end tracking is automatically activated. The measurement is continued with the last calculated dielectric constant.

The accuracy thus depends on the stability of the dielectric constant.

If you measure a medium with a dielectric constant below 1.5, probe end tracking is always active. In this case, you have to enter the dielectric constant of the medium. A stable dielectric constant is very important here.

Functional principle - interface measurement

High frequency microwave impulses are guided along a steel cable or rod. Upon reaching the product surface, a part of the microwave impulses is reflected. The other part passes through the upper product layers and is reflected by the interface. The running times to the two product layers are processed by the instrument.

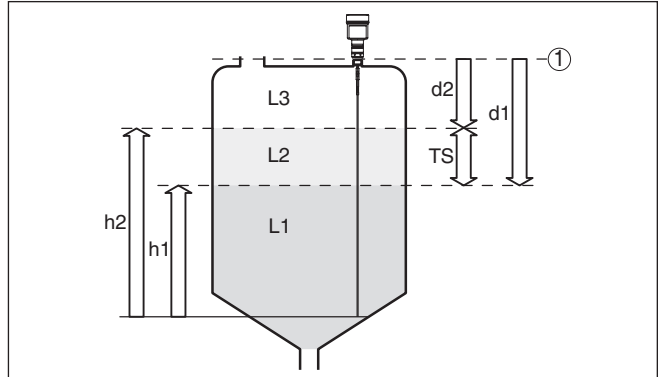

Fig. 4: Interface measurement

1 Sensor reference plane (seal surface of the process fitting)

d1 Distance to the interface (HART value 1)

d2 Distance to the level (HART value 3)

TS Thickness of the upper medium ($d1 - d2$)

h1 Height - Interface

h2 Height - Level

L1 Lower medium

L2 Upper medium

L3 Gas phase

Prerequisites for interface measurement

Upper medium (L2)

- The upper medium must not be conductive
- The dielectric constant of the upper medium or the actual distance to the interface must be known (input required). Min. dielectric constant: 1.6. You can find a list of dielectric constants on our home page: www.siemens.com.
- The composition of the upper medium must be stable, no varying products or mixtures
- The upper medium must be homogeneous, no stratifications within the medium
- Min. thickness of the upper medium 50 mm (1.97 in)
- Clear separation from the lower medium, emulsion phase or detritus layer max. 50 mm (1.97 in)
- If possible, no foam on the surface

Lower medium (L1)

- The dielectric constant must be 10 higher than the dielectric constant of the upper medium, preferably electrically conductive. Example: upper medium dielectric constant 2, lower medium at least dielectric constant 12.

Gas phase (L3)

- Air or gas mixture
- Gas phase - dependent on the application, gas phase does not always exist ($d_2 = 0$)

Output signal

The instrument is always preset to the application "*Level measurement*".

For the interface measurement, you can select the requested output signal with the setup.

3.3 Packaging, transport and storage

Packaging

Your instrument was protected by packaging during transport. Its capacity to handle normal loads during transport is assured by a test based on ISO 4180.

The packaging of standard instruments consists of environment-friendly, recyclable cardboard. For special versions, PE foam or PE foil is also used. Dispose of the packaging material via specialised recycling companies.

Transport

Transport must be carried out under consideration of the notes on the transport packaging. Nonobservance of these instructions can cause damage to the device.

Transport inspection

The delivery must be checked for completeness and possible transit damage immediately at receipt. Ascertained transit damage or concealed defects must be appropriately dealt with.

Storage

Up to the time of installation, the packages must be left closed and stored according to the orientation and storage markings on the outside.

Unless otherwise indicated, the packages must be stored only under the following conditions:

- Not in the open
- Dry and dust free
- Not exposed to corrosive media
- Protected against solar radiation
- Avoiding mechanical shock and vibration

Storage and transport temperature

- Storage and transport temperature see chapter "*Supplement - Technical data - Ambient conditions*"
- Relative humidity 20 ... 85 %

3.4 Accessories and replacement parts

Display and adjustment module

The display and adjustment module LG Local Display Interface is used for measured value indication, adjustment and diagnosis. It can be inserted into the sensor and removed at any time.

You can find additional information in the operating instructions manual "*LG Local Display Interface*" (Document-ID 43838).

External display and adjustment unit

The LG Remote Interface is an external display and adjustment unit for sensors with single chamber housing and Ex-d double chamber housing.

It is suitable for measured value indication and adjustment of sensors and is connected to the sensor with a four-wire standard cable up to 50 m (164 ft) long.

You can find additional information in the operating instructions manual "*LG Remote Interface*".

External display and adjustment unit with HART protocol

The LG Remote Interface is suitable for measured value indication and adjustment of sensors with HART protocol. It is looped into the 4 ... 20 mA/HART signal cable.

You can find additional information in the operating instructions manual "*LG Remote Interface*".

Electronics module

The electronics module SITRANS series LG is a replacement part for TDR sensors of SITRANS series LG. There is a different version available for each type of signal output.

You can find further information in the operating instructions manual "*Electronics module SITRANS series LG*".

Spacer

If you mount the SITRANS LG240 in a bypass tube or standpipe, you have to avoid contact to the bypass tube by using a spacer at the probe end.

You can find additional information in the operating instructions manual "*Centering*".

4 Mounting

4.1 General instructions

Protection against moisture

Protect your instrument further through the following measures against moisture penetration:

- Use the recommended cable (see chapter "*Connecting to power supply*")
- Tighten the cable gland
- Loop the connection cable downward in front of the cable gland

This applies particularly to:

- Outdoor mounting
- Installations in areas where high humidity is expected (e.g. through cleaning processes)
- Installations on cooled or heated vessels

Protective caps

In the case of instrument housings with self-sealing NPT threads, it is not possible to have the cable entries screwed in at the factory. The openings for the cable glands are therefore covered with red protective caps as transport protection.

Prior to setup you have to replace these protective caps with approved cable glands or close the openings with suitable blind plugs. The suitable cable glands and blind plugs come with the instrument.

Suitability for the process conditions

Make sure that all parts of the instrument exposed to the process are suitable for the existing process conditions.

These are mainly:

- Active measuring component
- Process fitting
- Process seal

Process conditions are particularly:

- Process pressure
- Process temperature
- Chemical properties of the medium
- Abrasion and mechanical influences

You can find the specifications of the process conditions in chapter "*Technical data*" as well as on the nameplate.

4.2 Mounting instructions

Installation position

Mount SITRANS LG240 in such a way that the distance to vessel installations or to the vessel wall is at least 300 mm (12 in). In non-metallic vessels, the distance to the vessel wall should be at least 500 mm (19.7 in).

During operation, the probe must not touch any installations or the vessel wall. If necessary, fasten the probe end.

In vessels with conical bottom it can be advantageous to mount the sensor in the center of the vessel, as measurement is then possible nearly down to the lowest point of the bottom. Keep in mind that

measurement all the way down to the tip of the probe may not be possible. The exact value of the min. distance (lower dead band) is stated in chapter "Technical data".

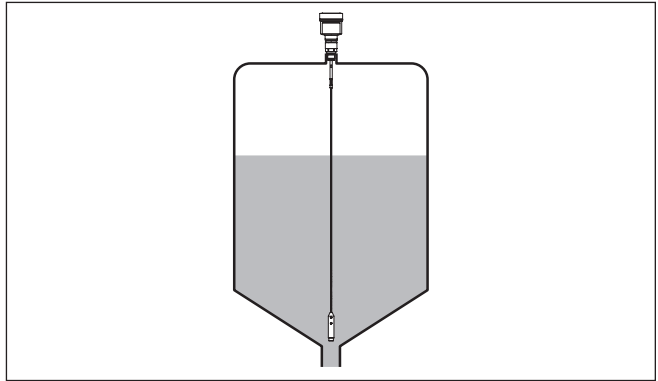

Fig. 5: Vessel with conical bottom

Type of vessel

Plastic vessel/Glass vessel

The guided microwave principle requires a metal surface on the process fitting. Therefore use in plastic vessels etc. an instrument version with flange (from DN 50) or place a metal sheet ($\varnothing > 200$ mm/8 in) beneath the process fitting when screwing it in.

Make sure that the plate has direct contact with the process fitting.

When installing rod or cable probes in vessels without metal walls, e.g. in plastic vessels, the measured value can be influenced by strong electromagnetic fields (emitted interference according to EN 61326: class A). In this case, use a probe with coaxial version.

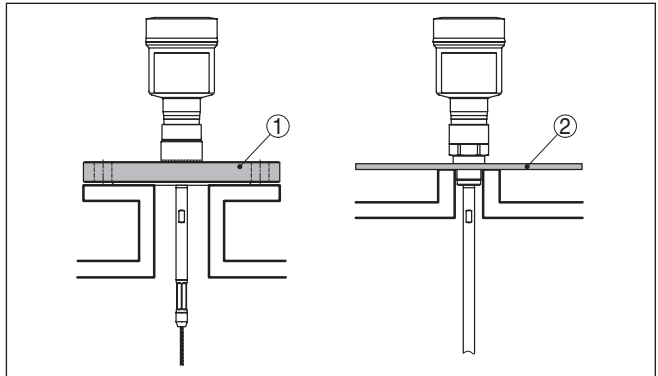

Fig. 6: Installation in non-metallic vessel

- 1 Flange
- 2 Metal sheet

Socket

If possible, avoid sockets. Mount the sensor flush with the vessel top. If this is not possible, use short sockets with small diameter.

Higher sockets or sockets with a bigger diameter can generally be used. They can, however, increase the upper blocking distance (dead band). Check if this is relevant for your measurement.

In such cases, always carry out a false signal suppression after installation. You can find further information under "*Setup procedure*".

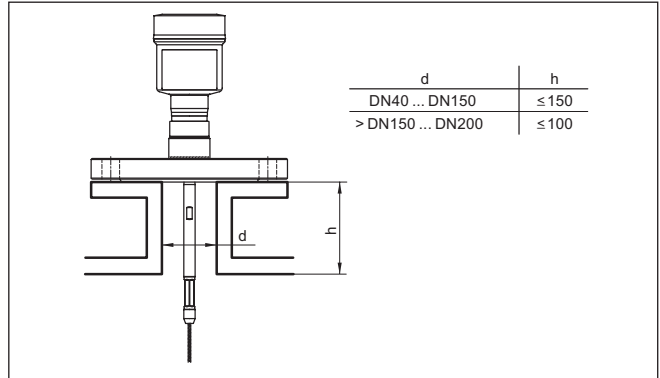

Fig. 7: Mounting socket

When welding the socket, make sure that the socket is flush with the vessel top.

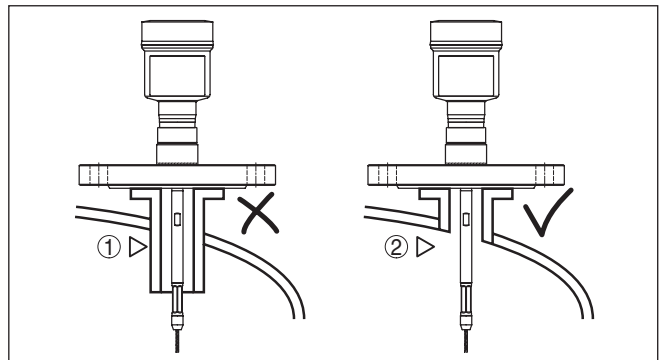

Fig. 8: Socket must be installed flush

- 1 Unfavourable installation
- 2 Socket flush - optimum installation

Welding work

Before beginning the welding work, remove the electronics module from the sensor. By doing this, you avoid damage to the electronics through inductive coupling.

Inflowing medium

Do not mount the instruments in or above the filling stream. Make sure that you detect the product surface, not the inflowing product.

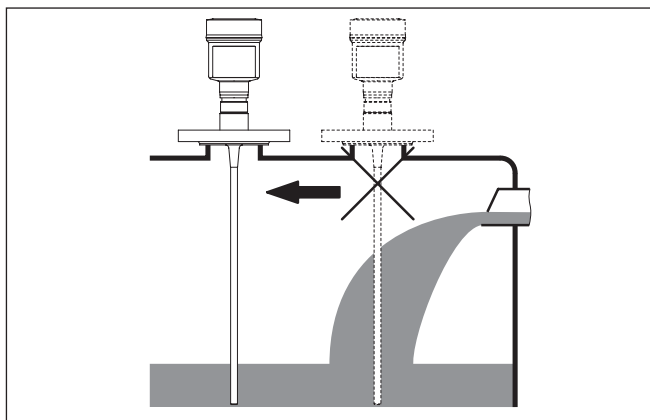

Fig. 9: Mounting of the sensor with inflowing medium

Measuring range

The reference plane for the measuring range of the sensors is the sealing surface of the thread or flange.

Keep in mind that a min. distance must be maintained below the reference plane and possibly also at the end of the probe - measurement in these areas is not possible (dead band). The length of the cable can be used all the way to the end only when measuring conductive products. These blocking distances for different mediums are listed in chapter "*Technical data*". Keep in mind for the adjustment that the default setting for the measuring range refers to water.

Pressure

The process fitting must be sealed if there is gauge or low pressure in the vessel. Before use, check if the seal material is resistant against the measured product and the process temperature.

The max. permissible pressure is specified in chapter "*Technical data*" or on the type label of the sensor.

Lateral installation

In case of difficult installation conditions, the probe can be also mounted laterally. For this purpose, adapt the rod with rod extensions or bow-shaped segments.

Let the probe length determine automatically by the instrument to compensate the resulting running time changes.

The determine probe length can deviate from the actual probe length when using bow-shaped segments.

If installations such as struts, ladders, etc. exist on the vessel wall, then the probe should have a distance to the vessel wall of at least 300 mm (11.81 in).

You can find further information in the supplementary instructions of the rod extension.

Rod extension

In case of difficult installation conditions, for example in a socket, the probe can be adapted respectively with a rod extension.

Let the probe length determine automatically by the instrument to compensate the resulting running time changes.

You can find further information in the supplementary instructions of the rod extension.

Torque with PTFE plated flanges

To compensate the normal bias voltage loss due to the seal materials, you have to use also disc springs in addition to the flange screws for fastening PTFE plated flanges.

The flange screws of SITRANS LG240 must always be tightened with a torque of approx. 60 Nm (44 lbf ft) so that the PTFE washer seals reliably.

5 Connecting to power supply

5.1 Preparing the connection

Safety instructions

Always keep in mind the following safety instructions:

- Connect only in the complete absence of line voltage
- If overvoltage surges are expected, overvoltage arresters should be installed

Voltage supply via mains voltage

In this case, the instrument is designed in protection class II. To maintain this protection class, it is absolutely necessary that the ground conductor be connected to the internal ground terminal. Take note of the general installation regulations.

Supply voltage and current signal are carried on separate connection cables if reliable separation is required. The supply voltage range can differ depending on the instrument version.

The data for power supply are specified in chapter "*Technical data*".

Voltage supply via low voltage

In this case, the instrument is designed in protection class II. Generally connect the instrument to vessel ground (potential equalization) or with plastic vessels to the next ground potential. For this purpose, a ground terminal is located laterally on the instrument housing.

Connection cable

An approved, three-wire installation cable with PE conductor is required for voltage supply with mains voltage.

The 4 ... 20 mA current output is connected with standard two-wire cable without screen. If electromagnetic interference is expected which is above the test values of EN 61326-1 for industrial areas, screened cable should be used.

For instruments with housing and cable gland, use cable with round cross-section. To ensure the seal effect of the cable gland (IP protection rating), you have to check for which cable outer diameter the cable gland is suitable.

- 5 ... 9 mm (0.20 ... 0.35 in)
- 6 ... 12 mm (0.24 ... 0.47 in)
- 10 ... 14 mm (0.40 ... 0.55 in)

Use a cable gland fitting the cable diameter.

Cable gland ½ NPT

With plastic housing, the NPT cable gland or the Conduit steel tube must be screwed without grease into the threaded insert.

Max. torque for all housings see chapter "*Technical data*".

Cable screening and grounding

If screened cable is necessary, connect the cable screen on both ends to ground potential. In the sensor, the screen must be connected directly to the internal ground terminal. The ground terminal on the outside of the housing must be connected to the potential equalisation (low impedance).

If potential equalisation currents are expected, the connection on the processing side must be made via a ceramic capacitor (e. g. 1 nF, 1500 V). The low-frequency potential equalisation currents are thus

suppressed, but the protective effect against high frequency interference signals remains.



Warning:

Significant potential differences exist inside galvanization plants as well as on vessels with cathodic corrosion protection. Considerable equalisation currents can flow over the cable screen if the screen is grounded on both ends.

To avoid this in such applications, the cable screen must be connected to ground potential only at one end (in the switching cabinet). The cable screen must **not** be connected to the internal ground terminal in the sensor and the outer ground terminal on the housing must **not** be connected to the potential equalisation!



Information:

The metallic parts of the instrument (process fitting, transmitter, concentric tube, etc.) are conductively connected with the inner and outer ground terminal on the housing. This connection exists either directly via connecting metallic parts or, in case of instruments with external electronics, via the screen of the special connection cable.

You can find specifications on the potential connections inside the instrument in chapter "*Technical data*".

5.2 Connection

Connection technology

The voltage supply and signal output are connected via the spring-loaded terminals in the housing.

The connection to the display and adjustment module or to the interface adapter is carried out via contact pins in the housing.



Information:

The terminal block is pluggable and can be removed from the electronics. To do this, lift the terminal block with a small screwdriver and pull it out. When reinserting the terminal block, you should hear it snap in.

Connection procedure

Proceed as follows:

1. Unscrew the housing cover
2. Loosen compression nuts of the cable glands
3. Remove approx. 10 cm (4 in) of the cable mantle (signal output), strip approx. 1 cm (0.4 in) insulation from the ends of the individual wires
4. Insert the cable into the sensor through the cable entry



Fig. 10: Connection steps 5 and 6

5. Insert the wire ends into the terminals according to the wiring plan



Information:

Solid cores as well as flexible cores with wire end sleeves are inserted directly into the terminal openings. In case of flexible cores without end sleeves, press the terminal from above with a small screwdriver; the terminal opening is freed. When the screwdriver is released, the terminal closes again.

6. Check the hold of the wires in the terminals by lightly pulling on them
 7. Connect the screen to the internal ground terminal, connect the outer ground terminal to potential equalisation in case of power supply via low voltage
 8. Connect the lead cable for power supply in the same way according to the wiring plan, in addition connect the ground conductor to the inner ground terminal when powered with mains voltage.
 9. Tighten the compression nut of the cable glands. The seal ring must completely encircle the cables
 10. Screw the housing cover back on
- The electrical connection is hence finished.



Information:

The terminal blocks are pluggable and can be removed from the housing insert. To do this, lift the terminal block with a small screwdriver and pull it out. When inserting the terminal block again, you should hear it snap in.

5.3 Wiring plan, double chamber housing



The following illustrations apply to the non-Ex as well as to the Ex-d version.

Electronics compartment

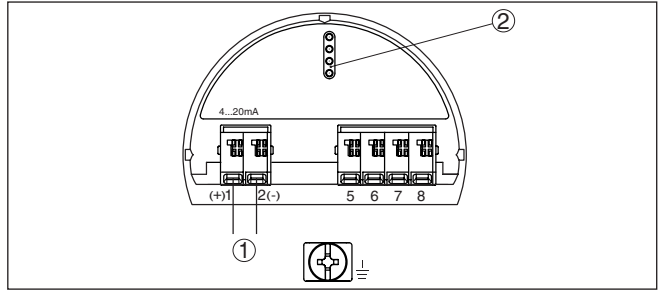

Fig. 11: Electronics compartment, double chamber housing

1 Internal connection to the connection compartment

2 For display and adjustment module or interface adapter



Information:

The connection of an external display and adjustment unit is not possible with this double chamber housing.

Connection compartment with mains voltage

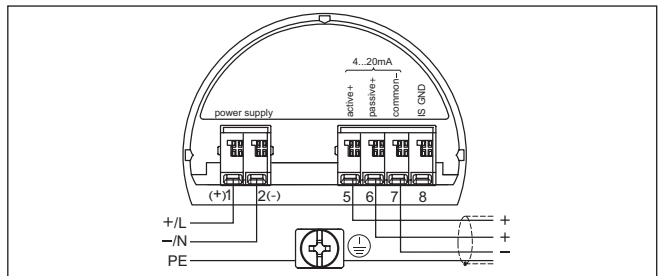

Fig. 12: Connection compartment with double chamber housing with mains voltage

| Terminal | Function | Polarity |
|----------|--|----------|
| 1 | Voltage supply | +/L |
| 2 | Voltage supply | -/N |
| 5 | 4 ... 20 mA output (active) | + |
| 6 | 4 ... 20 mA output (passive) | + |
| 7 | Mass - output | - |
| 8 | Function ground with installation according to CSA | |

Connection compartment with low voltage

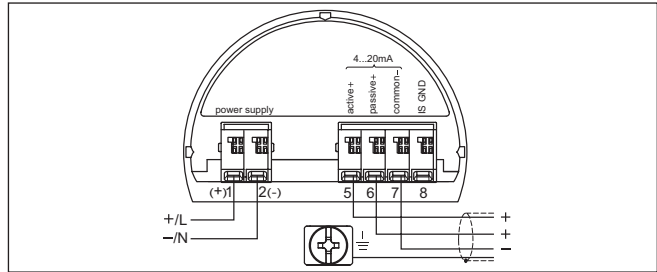

Fig. 13: Connection compartment with double chamber housing with low voltage

| Terminal | Function | Polarity |
|----------|--|----------|
| 1 | Voltage supply | +/L |
| 2 | Voltage supply | -/N |
| 5 | 4 ... 20 mA output (active) | + |
| 6 | 4 ... 20 mA output (passive) | + |
| 7 | Mass - output | - |
| 8 | Function ground with installation according to CSA | |

5.4 Supplementary electronics

Supplementary electronics - Second current output

You can use the supplementary electronics - second current output to provided a second measured value.

Both current outputs are passive and need a power supply.

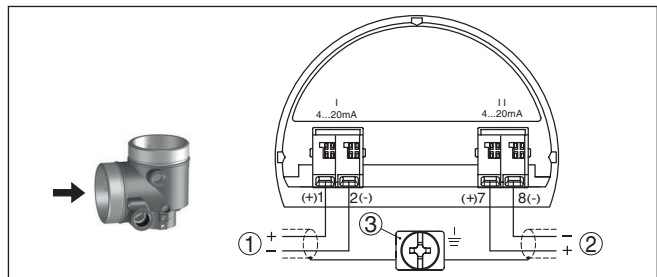

Fig. 14: Connection compartment double chamber housing, supplementary electronics - second current output

- 1 First current output (I) - Voltage supply and signal output (HART)
- 2 Second current output (II) - Voltage supply and signal output (without HART)
- 3 Ground terminal for connection of the cable screen

5.5 Switch-on phase

After connecting the instrument to power supply or after a voltage recurrence, the instrument carries out a self-check for approx. 30 s:

- Internal check of the electronics

-
- Indication of the instrument type, hardware and software version, measurement loop name on the display or PC
 - Indication of the status message "*F 105 Determine measured value*" on the display or PC
 - The output signal jumps to the set error current

As soon as a plausible measured value is found, the corresponding current is outputted to the signal cable. The value corresponds to the actual level as well as the settings already carried out, e.g. factory setting.

6 Set up with the display and adjustment module

6.1 Insert display and adjustment module

The display and adjustment module can be inserted into the sensor and removed any time. Four positions displaced by 90° can be selected. It is not necessary to interrupt the power supply.

Proceed as follows:

1. Unscrew the housing cover
2. Place the display and adjustment module in the requested position onto the electronics and turn to the right until it snaps in
3. Screw housing cover with inspection window tightly back on

Removal is carried out in reverse order.

The display and adjustment module is powered by the sensor, an additional connection is not necessary.



Fig. 15: Insertion of the display and adjustment module with single chamber housing into the electronics compartment

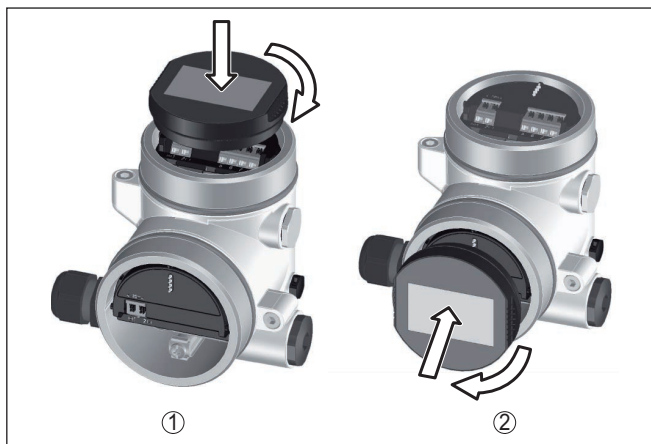

Fig. 16: Insertion of the display and adjustment module into the double chamber housing

- 1 In the electronics compartment
- 2 In the connection compartment (with Ex-d-ia version not possible)



Note:

If you intend to retrofit the instrument with a display and adjustment module for continuous measured value indication, a higher cover with an inspection glass is required.

6.2 Adjustment system

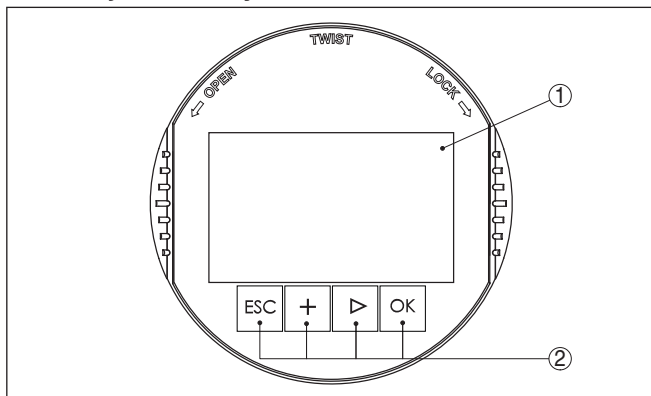

Fig. 17: Display and adjustment elements

- 1 LC display
- 2 Adjustment keys

- **[OK]** key:
 - Move to the menu overview
 - Confirm selected menu
 - Edit parameter

- Save value
- [->] key:
 - Presentation, change measured value
 - Select list entry
 - Select editing position
- [+] key:
 - Change value of the parameter
- [ESC] key:
 - Interrupt input
 - Jump to next higher menu

Adjustment system

The sensor is adjusted via the four keys of the display and adjustment module. The LC display indicates the individual menu items. The functions of the individual keys are shown in the above illustration. Approx. 10 minutes after the last pressing of a key, an automatic reset to measured value indication is triggered. Any values not confirmed with **[OK]** will not be saved.

Switch-on phase

After switching on, the SITRANS LG240 carries out a short self-test where the device software is checked.

The output signal transmits a fault signal during the switch-on phase.

The following information is displayed on the display and adjustment module during the startup procedure:

- Instrument type
- Device name
- Software version (SW-Ver)
- Hardware version (HW-Ver)

Measured value indication

With the [->] key you can move between three different indication modes.

In the first view, the selected measured value is displayed in large digits.

In the second view, the selected measured value and a corresponding bar graph presentation are displayed.

In the third view, the selected measured value as well as a second selectable value, e.g. the temperature, are displayed.



6.3 Parameter adjustment - Quick setup

Quick setup

To quickly and easily adapt the sensor to the application, select the menu item "Quick setup" in the start graphic on the display and adjustment module.

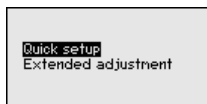

You can find "Extended adjustment" in the next sub-chapter.

General information

Measurement loop name

In the first menu item you can assign a suitable measurement loop name. You can enter a name with max. 19 characters.

Medium type

In the next menu item you can see which product type the instrument is suitable for. If your instrument is only suitable for a certain medium, this menu item is not visible.

Application

In this menu item, you can select the application. You can choose between level measurement and interface measurement. You can also choose between measurement in a vessel or in a bypass or standpipe.

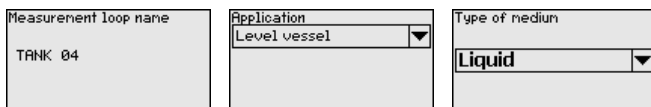

Level measurement

Medium - dielectric constant

In this menu item, you can define the medium type (product).

Max. adjustment

In this menu item, you can enter the max. adjustment for the level.

Enter the appropriate distance value in m (corresponding to the percentage value) for the full vessel. The distance refers to the sensor reference plane (seal surface of the process fitting). Keep in mind that the max. level must lie below the dead band.

Min. adjustment

In this menu item, you can enter the min. adjustment for the level.

Enter the suitable distance value in m for the empty vessel (e.g. distance from the flange to the probe end) corresponding to the percentage value. The distance refers to the sensor reference plane (seal surface of the process fitting).

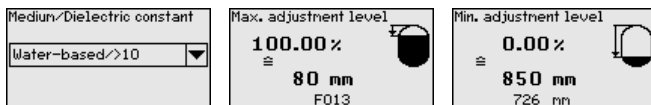

Interface measurement

Dielectric constant - upper medium

In this menu item, you can define the medium type (product).

Max. adjustment

In this menu item, you can enter the max. adjustment for the level.

Enter the appropriate distance value in m (corresponding to the percentage value) for the full vessel. The distance refers to the sensor

reference plane (seal surface of the process fitting). Keep in mind that the max. level must lie below the dead band.

Min. adjustment

In this menu item, you can enter the min. adjustment for the level.

Enter the suitable distance value in m for the empty vessel (e.g. distance from the flange to the probe end) corresponding to the percentage value. The distance refers to the sensor reference plane (seal surface of the process fitting).



Max. adjustment - Interface

Carry out the max. adjustment for the interface.

To do this, enter the percentage value and the suitable distance value in m for the full vessel.

Min. adjustment - Interface

Carry out the min. adjustment for the interface.

To do this, enter the percentage value and the suitable distance value in m for the empty vessel.

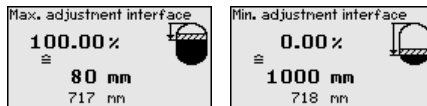

Linearization

Linearization

A linearization is necessary for all vessels in which the vessel volume does not increase linearly with the level - e.g. a horizontal cylindrical or spherical tank, when the indication or output of the volume is required. Corresponding linearization curves are preprogrammed for these vessels. They represent the correlation between the level percentage and vessel volume.

The linearization applies for the measured value indication and the current output. By activating the suitable curve, the percentage vessel volume is displayed correctly.

False signal suppression

High sockets and internal vessel installations cause interfering reflections and can influence the measurement.

A false signal suppression detects, marks and saves these false signals so that they are no longer taken into account for the level and interface measurement. We generally recommend carrying out a false signal suppression to achieve the best possible accuracy. This should be done with the lowest possible level so that all potential interfering reflections can be detected.

Enter the actual distance from the sensor to the product surface.

All interfering signals in this section are detected by the sensor and stored.

The instrument carries out an automatic false signal suppression as soon as the probe is uncovered. The false signal suppression is always updated.

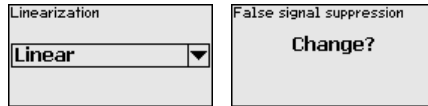

6.4 Parameter adjustment - Extended adjustment

For technically demanding measurement loops you can carry out extended settings in "Extended adjustment".

Main menu

The main menu is divided into five sections with the following functions:

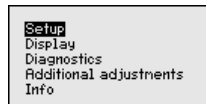

Setup: Settings, e.g. measurement loop name, medium, vessel, adjustment, signal output, device unit, false signal suppression, linearization curve

Display: Settings, e.g., for language, measured value display, lighting

Diagnosis: Information, e.g. on instrument status, pointer, measurement reliability, simulation, echo curve

Additional adjustments: Reset, date/time, reset, copy function

Info: Instrument name, hardware and software version, date of manufacture, instrument features



Note:

For optimum adjustment of the measurement, the individual submenu items in the main menu item "Setup" should be selected one after the other and provided with the correct parameters. If possible, go through the items in the given sequence.

The procedure is described below.

The following submenu points are available:

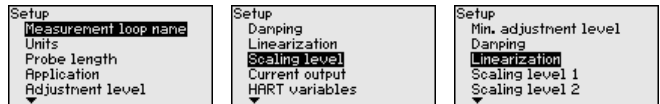

The submenu points described below.

Setup - Measurement loop name

Here you can assign a suitable measurement loop name. Push the "OK" key to start the processing. With the "+" key you change the sign and with the "->" key you jump to the next position.

You can enter names with max. 19 characters. The character set comprises:

- Capital letters from A ... Z
- Numbers from 0 ... 9

- Special characters + - / _ blanks

Measurement loop name
TANK 04

Setup - Units

In this menu item you select the distance unit and the temperature unit.

Distance unit
mm

Temperature unit
°C

With the distance units you can choose between m, mm and ft and with the temperature units between °C, °F and K.

Setup - Probe length

In this menu item you can enter the probe length or have the length determined automatically by the sensor system.

When choosing "Yes", then the probe length will be determined automatically. When choosing "No", you can enter the probe length manually.

Probe length
1000 mm

Probe length determine automatically?
 Yes
 No

Probe length
01000 mm

Setup - Type of medium

In this menu item you can select which type of medium you want to measure. You can choose between liquid or bulk solid.

Type of medium
Liquid

Type of medium
 Liquid
 Solid

Setup - Application

In this menu item, you can select the application. You can choose between level measurement and interface measurement. You can also choose between measurement in a vessel or in a bypass or standpipe.



Note:

The selection of the application has a considerable influence on all other menu items. Keep in mind that as you continue with the parameter adjustment, individual menu items are only optionally available.

You have the option of choosing the demonstration mode. This mode is only suitable for test and demonstration purposes. In this mode, the sensor ignores the parameters of the application and reacts immediately to each change.

You have to enter the tube inner diameter when measuring in a bypass or standpipe.

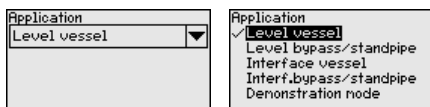

Setup - Application - Medium, dielectric constant

In this menu item, you can define the medium type (product).

This menu item is only available if you have selected level measurement under the menu item "Application".

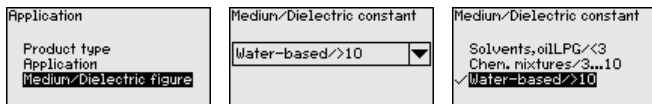

You can choose between the following medium types:

| Dielectric figure | Medium type | Examples |
|-------------------|---------------------|---|
| > 10 | Water-based liquids | Acids, alcalis, water |
| 3 ... 10 | Chemical mixtures | Chlorobenzene, nitro lacquer, aniline, isocyanate, chloroform |
| < 3 | Hydrocarbons | Solvents, oils, liquid gas |

Setup - Application - Gas phase

This menu item is only available, if you have chosen interface measurement under the menu item "Application". In this menu item you can enter if there is a superimposed gas phase in your application.

Only set the function to "Yes", if the gas phase is permanently present.

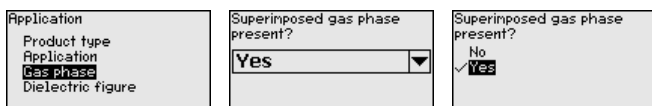

Setup - Application - Dielectric constant

This menu item is only available if you have selected interface measurement under the menu item "Application". In this menu item you can choose the medium type of the upper medium.

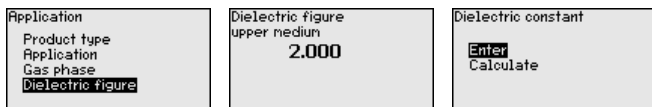

You can enter the dielectric constant of the upper medium directly or have the value determined by the instrument. To do this you have to enter the measured or known distance to the interface.

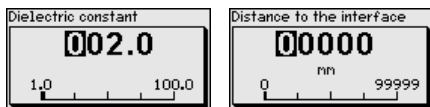

Setup - Max. adjustment Level

In this menu item you can enter the max. adjustment for the level. With interface measurement this is the maximum total level.

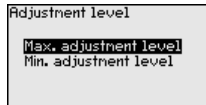

Adjust the requested percentage value with **[+]** and store with **[OK]**.

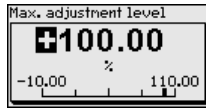

Enter the appropriate distance value in m (corresponding to the percentage value) for the full vessel. The distance refers to the sensor reference plane (seal surface of the process fitting). Keep in mind that the max. level must lie below the dead band.

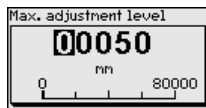

Setup - Min. adjustment Level

In this menu item you can enter the min. adjustment for the level. With interface measurement this is the minimum total level.

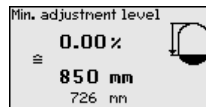
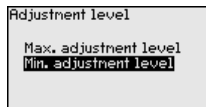

Adjust the requested percentage value with **[+]** and store with **[OK]**.

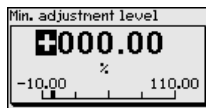

Enter the suitable distance value in m for the empty vessel (e.g. distance from the flange to the probe end) corresponding to the percentage value. The distance refers to the sensor reference plane (seal surface of the process fitting).

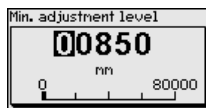

Setup - Max. adjustment Interface

This menu item is only available if you have selected interface measurement under the menu item "Application".

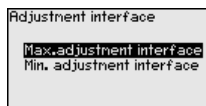

You can accept the adjustment of the level measurement also for the interface measurement. If you select "Yes", the current setting will be displayed.

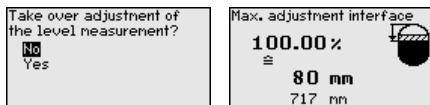

If you have selected "No", you can enter the adjustment for the interface separately. Enter the requested percentage value.

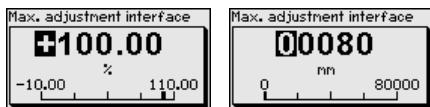

For the full vessel, enter the distance value in m matching the percentage value.

Setup - Min. adjustment - Interface

This menu item is only available if you have selected interface measurement under the menu item "Application". If you have selected "Yes" in the previous menu item (accept adjustment of the level measurement), the current setting will be displayed.

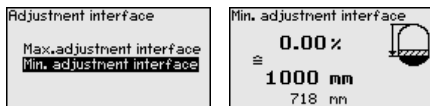

If you have selected "No", you can enter the adjustment for the interface measurement separately.

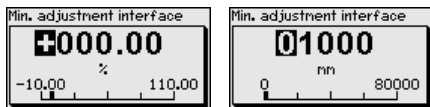

Enter the respective distance value in m for the empty vessel corresponding to the percentage value.

Setup - Damping

To damp process-dependent measured value fluctuations, set an integration time of 0 ... 999 s in this menu item.

If you have selected interface measurement under the menu item "Application", you can adjust the damping for the level and the interface separately.

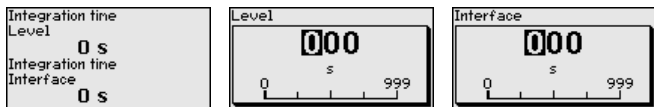

The default setting is a damping of 0 s.

Setup - Linearization

A linearization is necessary for all vessels in which the vessel volume does not increase linearly with the level - e.g. a horizontal cylindrical or spherical tank, when the indication or output of the volume is required. Corresponding linearization curves are preprogrammed for these vessels. They represent the correlation between the level percentage and vessel volume.

The linearization applies to the measured value indication and the current output. By activating the appropriate curve, the volume per-

centage of the vessel is displayed correctly. If the volume should not be displayed in percent but e.g. in l or kg, a scaling can be also set in the menu item "Display".

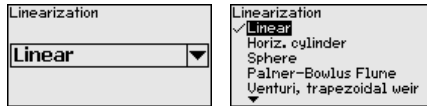

Warning:

If a linearization curve is selected, the measuring signal is no longer necessarily linear to the filling height. This must be considered by the user especially when adjusting the switching point on the limit signal transmitter.

In the following, you have to enter the values for your vessel, for example the vessel height and the socket correction.

For non-linear vessel forms, enter the vessel height und the socket correction.

For the vessel height, you have to enter the total height of the vessel.

For the socket correction you have to enter the height of the socket above the upper edge of the vessel. If the socket is lower than the upper edge of the vessel, this value can also be negative.

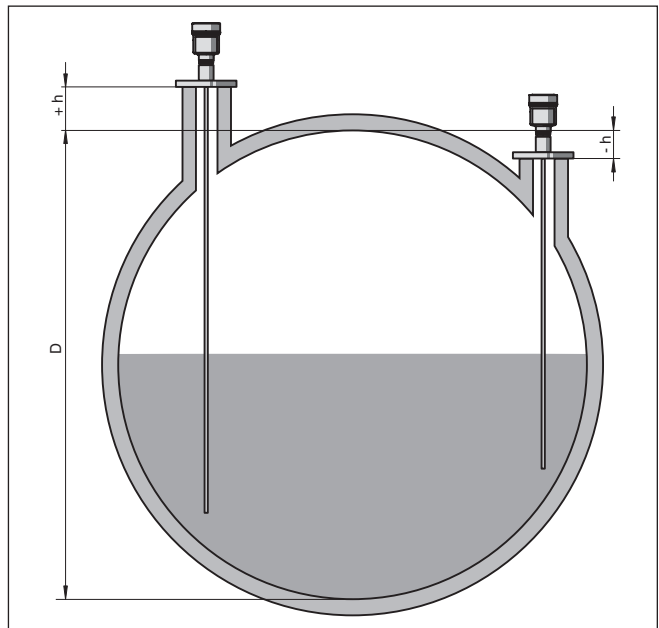
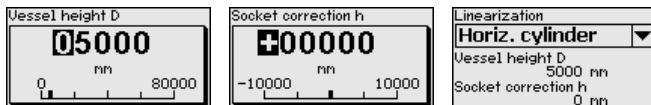

Fig. 18: Vessel height und socket correction value

D Vessel height

+h Positive socket correction value

-h Negative socket correction value



Setup - Scaling Level

Since scaling is very extensive, scaling of the level value was divided into two menu items.

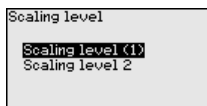

Setup - Scaling Level 1

In menu item "Level 1" you define the scaling variable and the scaling unit for the level value on the display, e.g. volume in l.

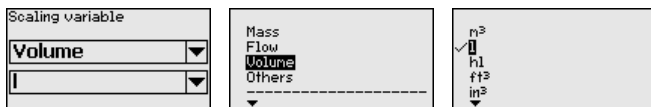

Setup - Scaling Level 2

Since scaling is very extensive, scaling of the level value was divided into two menu items.

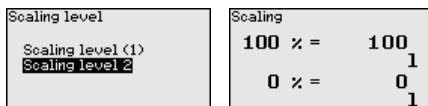

In menu item "Level 2" you define the scaling format on the display and the scaling of the measured level value for 0 % and 100 %.

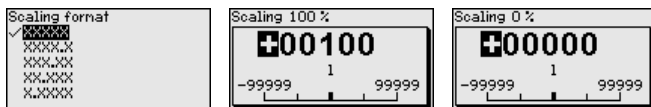

Setup - Scaling Interface

Since scaling is very extensive, scaling of the interface value was divided into two menu items.

Setup - Scaling Interface (1)

In menu item "Interface 1" you define the scaling size and the scaling unit for the interface value on the display, e.g. volume in l.

You can accept the scaling of the level measurement also for the interface measurement. If you select "Yes", the current setting is displayed.

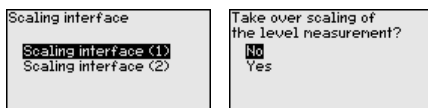

If you have selected "No", you can enter the scaling for the interface separately.

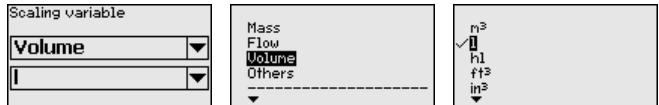

Setup - Scaling Interface (2)

In menu item "Interface (2)" you define the scaling format on the display and the scaling of the interface measured value for 0 % and 100 %.

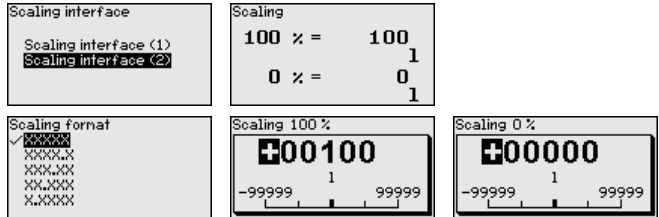

Setup - Current output Size

In menu item "Current output, size" you determine which measured value the current output refers to.

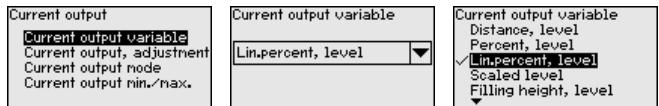

Setup - Current output, adjustment

In menu item "Current output, adjustment" you can assign a respective measured value to the current output.

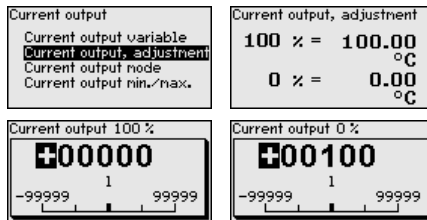

Setup - Current output mode

In the menu item "Current output mode" you determine the output characteristics and reaction of the current output in case of failure.

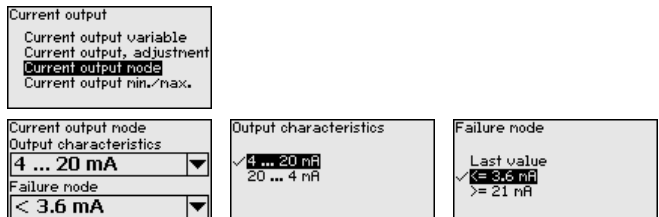

The default setting is output characteristics 4 ... 20 mA, failure mode < 3.6 mA.

Setup - Current output Min./Max.

In the menu item "Current output Min./Max.", you determine the reaction of the current output during operation.

Current output
Current output variable
Current output, adjustment
Current output mode
Current output min./max.

Current output min./max.
Min. current
4 mA
Max. current
20 mA

Min. current
3.8 mA
4 mA

Max. current
20 mA
20.5 mA

The default setting is min. current 3.8 mA and max. current 20.5 mA.

Setup - HART variables (1)

Since the HART variables are very extensive, the indication was divided into two menu items.

In the menu "HART variables 1" you can have the first HART value PV (primary value) and the second HART value SV (secondary value) of the sensor displayed.

The values cannot be changed in the display and adjustment module. To change these values, you have to use the adjustment software PACTware.

HART variables
HART variables (1)
HART variables (2)

First HART value (PV)
Lin.percent, level

Second HART value (SV)
Distance, level

Setup - HART variables (2)

In the menu "HART variables 2" you can have the third HART value TV (third value) and the fourth HART value QV (quarter value) of the sensor displayed.

The values cannot be changed in the display and adjustment module. To change these values, you have to use the adjustment software PACTware.

HART variables
HART variables (1)
HART variables (2)

Third HART value (TV)
Meas. reliability, level

Fourth HART value (QV)
Electronics temperature

Setup - False signal suppression

The following circumstances cause interfering reflections and can influence the measurement:

- High sockets
- Vessel installations such as struts



Note:

A false signal suppression detects, marks and saves these false signals so that they are no longer taken into account for the level and interface measurement. We generally recommend carrying out a false signal suppression to achieve the best possible accuracy. This should be done with the lowest possible level so that all potential interfering reflections can be detected.

Proceed as follows:

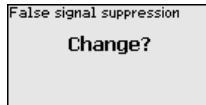

Enter the actual distance from the sensor to the product surface.

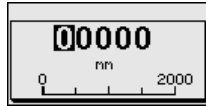

All interfering signals in this section are detected by the sensor and stored.



Note:

Check the distance to the product surface, because if an incorrect (too large) value is entered, the existing level will be saved as a false echo. The filling level would then no longer be detectable in this area. If a false signal suppression has already been created in the sensor, the following menu window appears when selecting "*False signal suppression*":

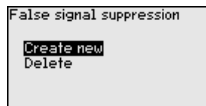

The instrument carries out an automatic false signal suppression as soon as the probe is uncovered. The false signal suppression is always updated.

The menu item "*Delete*" is used to completely delete an already created false signal suppression. This is useful if the saved false signal suppression no longer matches the metrological conditions in the vessel.

Lock/release setup - Adjustment

In the menu item "*Lock/unlock adjustment*", you can protect the sensor parameters against unauthorized modification. The PIN is activated/deactivated permanently.

The following adjustment functions are possible without entering the PIN:

- Select menu items and show data
- Read data from the sensor into the display and adjustment module.

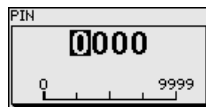

Caution:

With active PIN, adjustment via PACTware/DTM as well as other systems is also blocked.

You can change the PIN number under "*Additional adjustments - PIN*".

Display

In the main menu point "*Display*", the individual submenu points should be selected subsequently and provided with the correct parameters to ensure the optimum adjustment of the display options. The procedure is described in the following.

The following submenu points are available:

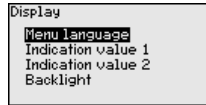

The submenu points described below.

Display - Menu language

This menu item enables the setting of the requested national language.

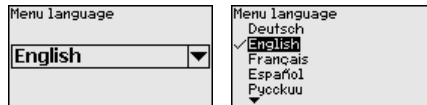

In the delivery status, the sensor is set to the ordered national language.

Display - Displayed value 1

In this menu item, you define the indication of the measured value on the display. You can display two different measured values. In this menu item, you define measured value 1.

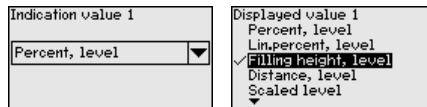

The default setting for the displayed value 1 is "*Filling height Level*".

Display - Displayed value 2

In this menu item, you define the indication of the measured value on the display. You can display two different measured values. In this menu item, you define measured value 2.

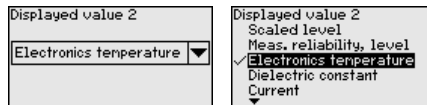

The default setting for the displayed value 2 is the electronics temperature.

Display - Backlight

The optionally integrated background lighting can be adjusted via the adjustment menu. The function depends on the height of the supply voltage, see "*Technical data*".



The lighting is switched off in the delivery status.

Diagnostics - Device status

In this menu item, the device status is displayed.

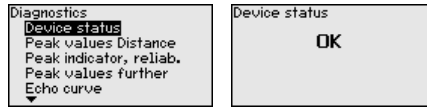

Diagnostics - Peak values Distance

The respective min. and max. measured value is saved in the sensor. The two values are displayed in the menu item "*Peak values, distance*".

If you have selected interface measurement under the menu item "*Setup - Application*", the peak values of the interface measurement are displayed in addition to the peak values of the level measurement.

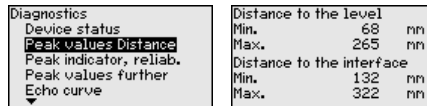

In another window you can carry out a reset of the two peak values separately.

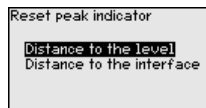

Diagnostics - Peak values Measurement certainty

The respective min. and max. measured values are saved in the sensor. The two values are displayed in the menu item "*Peak values, measurement certainty*".

The measurement can be influenced by the process conditions. In this menu item, the measurement certainty of the level measurement is displayed as percentage value. The higher the value, the more reliable the measurement. Values > 90 % indicate reliable measurement.

If you have selected interface measurement under the menu item "*Setup - Application*", the peak values of the interface measurement are displayed in addition to the peak values of the level measurement.

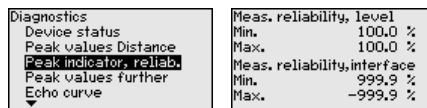

In another window you can carry out a reset of the two peak values separately.

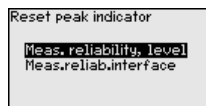

Diagnostics - Peak values Additional

The respective min. and max. measured values are saved in the sensor. The values are displayed in the menu item "*Peak values Additional*".

This menu item displays the peak values of the electronics temperature as well as the dielectric constant.

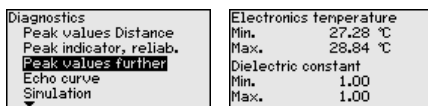

In another window you can carry out a reset of the two peak values separately.

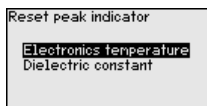

Diagnostics - Echo curve

The menu item "Echo curve" shows the signal strength of the echoes over the measuring range in V. The signal strength enables an evaluation of the quality of the measurement.

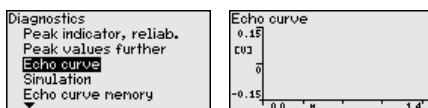

With the following functions you can zoom part sections of the echo curve.

- "X-Zoom": Zoom function for the meas. distance
- "Y-Zoom": 1, 2, 5 and 10x signal magnification in "V"
- "Unzoom": Reset the presentation to the nominal measuring range with single magnification

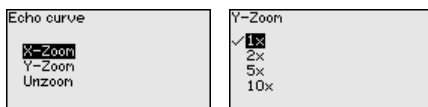

Diagnosis - Simulation

In this menu item you can simulate measured values via the current output. This allows the signal path to be tested, e.g. via downstream indicating instruments or the input card of the control system.

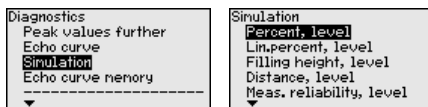

Select the requested simulation size and adjust the requested value.

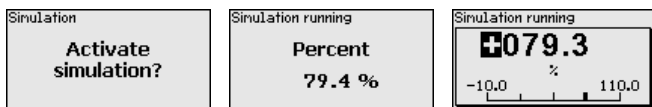

Caution:

During simulation, the simulated value is outputted as 4 ... 20 mA current value and digital HART signal.

Push the **[ESC]** key to deactivate the simulation.



Information:

The simulation is terminated automatically 60 minutes after the last key has been pushed.

Diagnostics - Echo curve memory

With the menu item "Setup" the echo curve it is possible to save at the time of setup. This is generally recommended; for using the Asset Management functions it is necessary. If possible, the curve should be saved with a low level in the vessel.

With this, you can detect signal changes over the operating time. With the adjustment software PACTware and the PC, the high-resolution echo curve can be displayed and used to compare the echo curve of the setup with the actual echo curve.



The function "Echo curve memory" enables storing echo curves of the measurement.

Under the sub-menu item "Echo curve memory" you can store the current echo curve.

Parameter settings for recording the echo curve and the settings of the echo curve itself can be carried out in the adjustment software PACTware.

With the adjustment software PACTware and the PC the high-resolution echo curve can be displayed and used later on to assess the quality of the measurement.

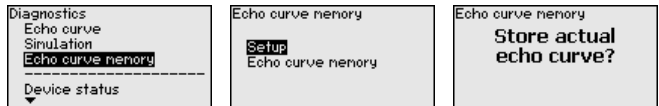

Additional settings - PIN

Entering a 4-digit PIN protects the sensor data against unauthorized access and unintentional modification. In this menu item, the PIN is displayed or edited and changed. However, this menu item is only available if adjustment is enabled in the menu "Lock/Release setup/adjustment".

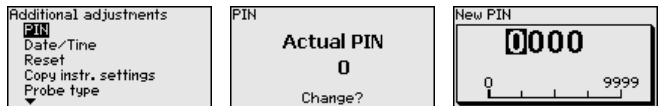

In delivery status, the PIN is "0000".

Additional adjustments - Date Time

In this menu item, the internal clock of the sensor is adjusted.

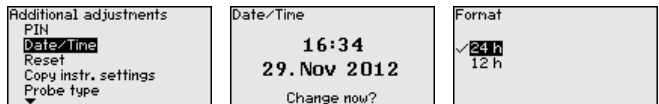



Additional adjustments - Reset

With a reset, certain parameter adjustments carried out by the user are reset.

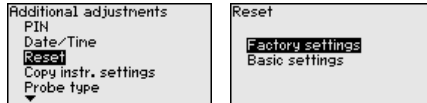

The following reset functions are available:

Delivery status: Restoring the parameter settings at the time of shipment from the factory incl. the order-specific settings. A created false signal suppression, user-programmable linearization curve as well as the measured value memory will be deleted.

Basic settings: Resetting the parameter settings incl. special parameters to the default values of the respective instrument. A created false signal suppression, user programmable linearization curve as well as the measured value memory will be deleted.

The following table shows the default values of the instrument. Depending on the instrument version or application, all menu items may not be available or some may be differently assigned:

Setup

| Menu item | Default value | Modified value |
|---|--|----------------|
| Block adjustment | Released | |
| Measurement loop name | Sensor | |
| Units | Distance unit: mm Temperature unit: °C | |
| Probe length | Length of the probe Ex factory | |
| Medium type | Liquid | |
| Application | Level, vessel | |
| Medium, dielectric constant | Water-based, > 10 | |
| Superimposed gas phase | Yes | |
| Dielectric figure, upper medium (TS) | 1.5 | |
| Tube inner diameter | 200 mm | |
| Max. adjustment - Level | 100 % | |
| Max. adjustment - Level | Distance: 0.000 m(d) - note blocking distances | |
| Min. adjustment - Level | 0 % | |
| Min. adjustment - Level | Distance: Probe length - take dead band into account | |
| Accept adjustment of the level measurement? | Yes | |

| Menu item | Default value | Modified value |
|---|--|----------------|
| Max. adjustment - Interface | 100 % | |
| Max. adjustment - Interface | Distance: 0.000 m(d) - note blocking distances | |
| Min. adjustment - Interface | 0 % | |
| Min. adjustment - Interface | Distance: Probe length - take dead band into account | |
| Integration time - Level | 0.0 s | |
| Integration time - Interface | 0.0 s | |
| Linearization type | Linear | |
| Linearization - Socket correction | 0 mm | |
| Linearization - Vessel height | Probe length | |
| Scaling size - Level | Volume in l | |
| Scaling unit - Level | Litres | |
| Scaling format - Level | Without decimal positions | |
| Scaling level - 100 % correspond to | 100 | |
| Scaling level - 0 % correspond to | 0 | |
| Accept scaling of the level measurement | Yes | |
| Scaling variable - Interface | Volume | |
| Scaling unit - Interface | Litres | |
| Scaling format - Interface | Without decimal positions | |
| Scaling interface - 100 % correspond to | 100 | |
| Scaling interface - 0 % correspond to | 0 | |
| Current output, output variable First HART variable (PV) | Lin. percent - Level | |
| Current output - Output characteristics | 0 ... 100 % correspond to 4 ... 20 mA | |
| Current output - Reaction in case of failure | ≤ 3.6 mA | |
| Current output - Min. | 3.8 mA | |
| Current output - Max. | 20.5 mA | |
| Current output 2 - Output variable Second HART variable (SV) | Distance - Level | |
| Current output 2 - Output characteristics | 0 ... 100 % correspond to 4 ... 20 mA | |
| Current output 2 - Reaction in case of failure | ≤ 3.6 mA | |
| Current output 2 - Min. | 3.8 mA | |
| Current output 2 - Max. | 20.5 mA | |
| Third HART variable (TV) | Measurement certainty, level | |
| Fourth HART variable (QV) | Electronics temperature | |

Display

| Menu item | Default value | Modified value |
|-------------------|-------------------------|----------------|
| Language | Order-specific | |
| Displayed value 1 | Filling height Level | |
| Displayed value 2 | Electronics temperature | |
| Backlight | Switched off | |

Diagnostics

| Menu item | Default value | Modified value |
|--|--|----------------|
| Status signals - Function control | Switched on | |
| Status signals - Out of specification | Switched off | |
| Status signals - Maintenance | Switched off | |
| Device memory - Echo curve memory | Stopped | |
| Device memory - Measured value memory | Started | |
| Device memory - Measured value memory - Measured values | Distance level, percentage value level, reliability level, electronics temperature | |
| Device memory - Measured value memory - Recording in time interval | 3 min. | |
| Device memory - Measured value memory - Recording with measured value difference | 15 % | |
| Device memory - Measured value memory - Start with measured value | Not active | |
| Device memory - Measured value memory - Stop with measured value | Not active | |
| Device memory - Measured value memory - Stop recording when memory is full | Not active | |

Additional adjustments

| Menu item | Default value | Modified value |
|---------------|-----------------|----------------|
| PIN | 0000 | |
| Date | Actual date | |
| Time | Actual time | |
| Time - Format | 24 hours | |
| Probe type | Device-specific | |

Additional adjustments - Copy instrument settings

The instrument settings are copied with this function. The following functions are available:

- Read from sensor: Read data from sensor and store into the display and adjustment module
- Write into sensor: Store data from the display and adjustment module back to the sensor

The following data or settings for adjustment of the display and adjustment module are saved:

- All data of the menu "Setup" and "Display"
- In the menu "Additional adjustments" the items "Reset, Date/Time"
- Special parameters



The copied data are permanently saved in an EEPROM memory in the display and adjustment module and remain there even in case of power failure. From there, they can be written into one or more sensors or kept as backup for a possible electronics exchange.



Note:

Before the data are stored in the sensor, a check is carried out to determine if the data fit the sensor. If the data do not fit, a fault signal is triggered or the function is blocked. When data are being written into the sensor, the display shows which instrument type the data originate from and which TAG-no. this sensor had.

Additional adjustments - Probe type

In this menu item you can select the type and size of your probe from a list of all possible probes. This is necessary to adapt the electronics optimally to the probe.

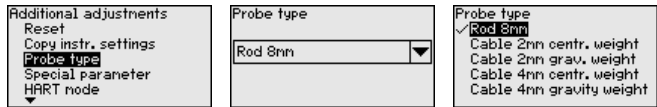

Additional adjustments - Special parameters

In this menu item you gain access to the protected area where you can enter special parameters. In exceptional cases, individual parameters can be modified in order to adapt the sensor to special requirements.

Change the settings of the special parameters only after having contacted our service staff.



Additional adjustments - HART mode

The sensor offers the HART modes "Analogue current output" and "Fix current (4 mA)". In this menu item you determine the HART mode and enter the address with Multidrop mode.

In the mode "Fixed current output" up to 63 sensors can be operated on one two-wire cable (Multidrop operation). An address between 0 and 63 must be assigned to each sensor.

If you select the function "Analogue current output" and also enter an address number, you can output a 4 ... 20 mA signal in Multidrop mode.

With the mode "Fixed current (4 mA)" a fixed 4 mA signal is outputted independently of the actual level.

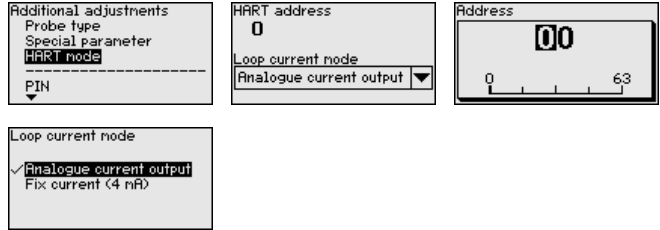

The default setting is "Analogue current output" and the address 00.

Info - Instrument name

In this menu, you read out the instrument name and the instrument serial number:

Info - Instrument version

In this menu item, the hardware and software version of the sensor is displayed.



Info - Factory calibration date

In this menu item, the date of factory calibration of the sensor as well as the date of the last change of sensor parameters are displayed via the display and adjustment module or via the PC.

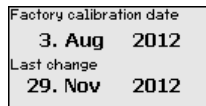

Info - Sensor characteristics

In this menu item, the features of the sensor such as approval, process fitting, seal, measuring range, electronics, housing and others are displayed.



6.5 Saving the parameter adjustment data

We recommended noting the adjusted data, e.g. in this operating instructions manual, and archiving them afterwards. They are thus available for multiple use or service purposes.

If the instrument is equipped with a display and adjustment module, the data in the sensor can be saved in the display and adjustment module. The procedure is described in the operating instructions manual "Display and adjustment module" in the menu item "Copy sensor data". The data remain there permanently even if the sensor power supply fails.

The following data or settings for adjustment of the display and adjustment module are saved:

- All data of the menu "*Setup*" and "*Display*"
- In the menu "*Additional adjustments*" the items "*Sensor-specific units, temperature unit and linearization*"
- The values of the user programmable linearization curve

The function can also be used to transfer settings from one instrument to another instrument of the same type. If it is necessary to exchange a sensor, the display and adjustment module is inserted into the replacement instrument and the data are likewise written into the sensor via the menu item "*Copy sensor data*".

7 Setup with PACTware

7.1 Connect the PC

Connection via HART

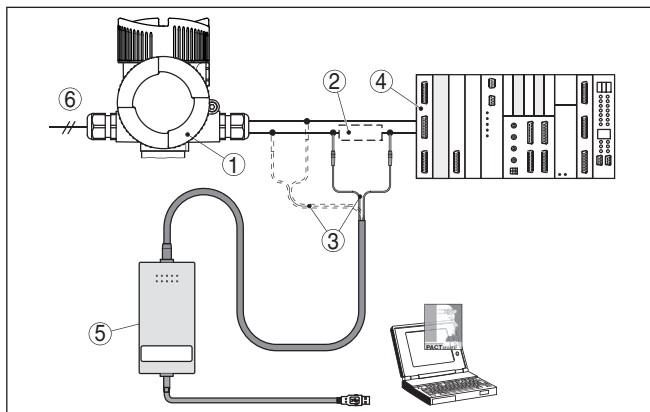

Fig. 19: Connecting the PC via HART to the signal cable

- 1 SITRANS LG240
- 2 HART resistance approx. 250 Ω (optional depending on processing)
- 3 Connection cable with 2 mm pins and terminals
- 4 Processing system/PLC
- 5 HART modem
- 6 Voltage supply

Necessary components:

- SITRANS LG240
- PC with PACTware and suitable DTM
- HART modem
- HART resistance approx. 250 Ω
- Processing system/PLC

7.2 Parameter adjustment with PACTware

Prerequisites

For parameter adjustment of the sensor via a Windows PC, the configuration software PACTware and a suitable instrument driver (DTM) according to FDT standard are required. The available DTMs are compiled on a DVD. The DTMs can also be integrated into other frame applications according to FDT standard.



Note:

To ensure that all instrument functions are supported, you should always use the latest DTM. Furthermore, not all described functions are included in older firmware versions. You can download the latest instrument software from our homepage. A description of the update procedure is also available in the Internet.

The further setup steps are described in the online help of PACTware and the DTMs.

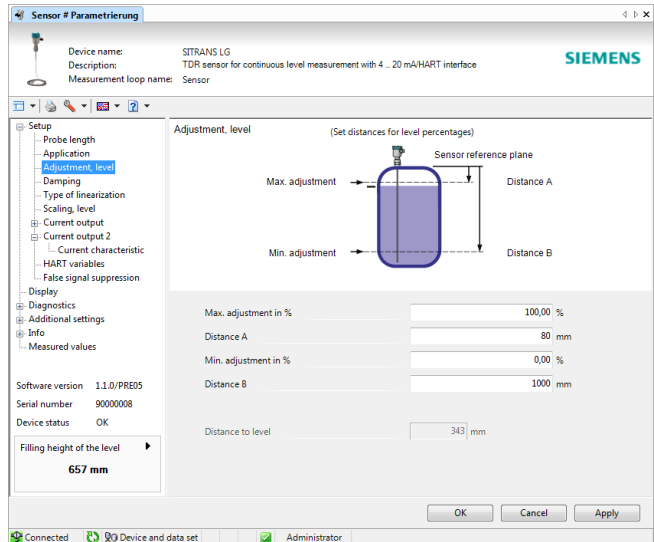

Fig. 20: Example of a DTM view

Device DTMs

The device DTM includes an assistant for simple project configuration simplifying the adjustment considerably. You can save and print your project documentation as well as import and export projects.

You can also save measured value and echo curves in the DTM. Furthermore a tank calculation program as well as a multiviewer for indication and analysis of the saved measured value and echo curves are available.

The supplied DVD includes the respective device DTM. However, you can also download the DTM from our homepage www.siemens.com.

7.3 Set up with the quick setup

General information

The quick setup is another option for parameter adjustment of the sensor. It allows fast, convenient adjustment of the most important parameters to adapt the sensor quickly to standard applications. To use it, select the function "Quick setup" in the start screen.

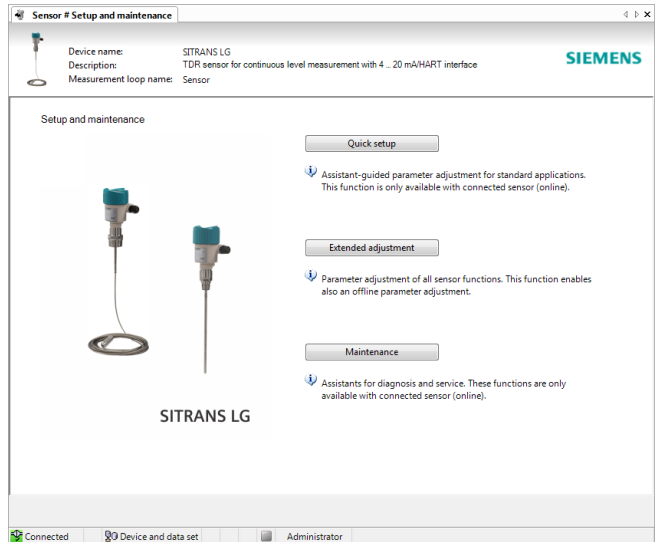

Fig. 21: Select quick setup

- 1 Quick setup
- 2 Extended adjustment
- 3 Maintenance

Quick setup

With quick setup you can carry out the parameter adjustment of SITRANS LG240 for your application in just a few simple steps. The assistant-driven adjustment includes the basic settings for simple, reliable setup and commissioning.



Information:

If the function is inactive, then possibly no instrument is connected. Check the connection to the instrument.

Extended adjustment

With the extended adjustment, you carry out the parameter adjustment for the instrument via the clear menu structure in the DTM (Device Type Manager). This enables additional and special settings over and above those offered by quick setup.

Maintenance

Under the menu item "Maintenance" you get comprehensive and important support for servicing and maintenance. You can call up diagnostic functions and carry out an electronics exchange or a software update.

Start quick setup

Click to the button "Quick setup", to start the assistant-driven adjustment for a simplified and reliable setup.

Step 1 Instrument configuration

Device name

Here, you can find the instrument name. You cannot change this line because the instrument name is unmodifiably saved in the instrument.

Serial number

Here, you can find the serial number of your instrument. You cannot change this line because the serial number is unmodifiably saved in the instrument.

Measurement loop name

Here you can enter a suitable measurement loop name for your SITRANS LG240. You can enter a name with max. 19 characters. You can use capital and small letters as well as numbers. The following special characters are also possible: + - . : , () / < >

Probe length modified?

If you have modified the probe length, this must be entered in the selection field.

- If you select "No", then the instrument uses automatically the preset length of the default setting.
- If you select "Yes", then you can enter in another field the modified length of the instrument.

Probe length L from seal surface

If you have modified the length of the probe, you can enter in this field the modified probe length. Keep the selected unit in mind.

Determine probe length automatically

If you do not know the probe length, you can have the length of the probe determined automatically. The requirement for this is a probe unrestricted and not covered by the medium.

Click to "*Carry out now*", to start the automatic length determination.

Step 2 Application

Medium type

Here you can see which medium type your instrument is suitable for. If this function is inactive, the medium type your instrument is suitable for was already preset.



Information:

In special cases you can change the medium type. This setting can be changed under "*Extended adjustment*".

Application

In this field you can select the application you want to use your instrument for. You have the following selection options:

- Level in the vessel
- Level in the bypass/standpipe
- Interface in the vessel
- Interface in the bypass/standpipe
- Demonstration mode

Level measurement: If you select "Level", you can select the properties of the medium in another field.

Interface measurement: If you select "Interface", the instrument needs more information, such as the distance to the interface, the dielectric constant of the upper medium or whether or not there is a superimposed gas phase.

Demonstration mode: This mode is only suitable for test and demonstration purposes. In this mode, the sensor ignores all parameters and reacts immediately to all measured value changes within the measuring range.

Application - Level measurement

The level measurement refers to the product surface which is the limit to the gas phase.

- Liquids
 - Solvents, oils, LPG - dielectric constant < 3
 - Chemical mixtures - dielectric constant 3 ... 10
 - Water-based - dielectric constant > 10
- Bulk solids
 - Dusts, wood chips - dielectric constant < 1.5
 - Granules, dusts, powders - dielectric constant 1.5 ... 3
 - Cereals, flour - dielectric constant > 3

Application - Interface measurement

The interface measurement refers to the phase limit between two liquids. The total level is also available as a measured value.

- Superimposed gas phase present
 - Check if there is a superimposed gas phase in the vessel. This is always the case if the total level never touches the process fitting.
- Properties
 - Here you can enter the dielectric constant of the upper medium
 - As an alternative you can enter the distance to the interface

Step 3 Adjustment

Adjustment for the level measurement

If you have selected level measurement in the previous menu, then you can enter the values for the min. and max. adjustment. The value to be entered refers to the distance from the sealing surface of the process fitting (sensor reference plane) to the surface of the product.

Adjustment for the level and interface measurement

If you have selected interface measurement in the previous menu, then you can enter the values for the min. and max. adjustment of level and interface or accept the values of the level measurement. The entered value refers to the distance from the sealing surface of the process fitting (sensor reference plane) to the total level or interface.

Step 4 Linearization

Linearization is required if the measured value should be outputted in proportion to the volume and not the level. The linearization acts identically on the level and the interface measurement. You can find further linearization types in the extended adjustment.

If you have a non-linear vessel, you can select here the respective linearization curve.

- Linear
- Spherical tank
- Horizontal cylindrical tank

You must enter the following vessel dimensions with non-linear conditions:

- Height of the socket h
- Vessel height D

Step 5 Setting - Output signal

In this window you can adjust the output signal. When the function is inactive, you can change the settings via the "*Extended adjustment*".

Step 6 Sensor optimization

These settings allow you to optimize the sensor. With them you can compare a sounded distance with the indicated value and correct it, if necessary.

Probe immersed in the liquid (covered)

Select whether or not the probe is immersed in the medium.

Measured distance to the medium

If the probe is immersed in the medium, you can enter here the measured distance to the medium.

Displayed distance correct?

Is the displayed distance value correct? If you have the possibility, you can enter here the sounded distance to the medium.

False signal suppression

With this function you can carry out the automatic false signal suppression. We recommend carrying out false signal suppression in any case.

Step 7 Additional settings

When the setup of the instrument is finished, additional settings can be made. These are various backups and the locking of the instrument against unauthorised or inadvertent adjustment.

Prepare a backup file of the instrument parameter adjustment?

For backup purposes, the current parameter adjustment of the instrument is stored in a file. You can use this file later on to restore the instrument parameter adjustment. The complete data set is downloaded from the device. This procedure can last several minutes.

Create instrument documentation?

This function is used to print or create a PDF file of the current parameter adjustment. To read the PDF file, you need a suitable program (for example Acrobat Reader). To print or create the PDF file, all data are downloaded from the device. For this function, the full version of the DTM Collection is required. This procedure can last several minutes.

Store echo curve of the setup in the sensor?

Have you completed the initial setup of the instrument? In such case, we recommend storing the current signal conditions in the device for later instrument tests and diagnostics.

Lock adjustment with PIN after setting?

The instrument is locked with the current PIN. A parameter adjustment is possible only after the PIN is entered again.

7.4 Saving the parameter adjustment data

We recommend documenting or saving the parameter adjustment data via PACTware. That way the data are available for multiple use or service purposes.

8 Set up with other systems

8.1 DD adjustment programs

Device descriptions as Enhanced Device Description (EDD) are available for DD adjustment programs such as, for example, AMS™ and PDM.

8.2 Field Communicator 375, 475

Device descriptions for the instrument are available as EDD for parameter adjustment with the Field Communicator 375 or 475.

9 Diagnostics and service

9.1 Maintenance

If the device is used correctly, no maintenance is required in normal operation.

9.2 Diagnosis memory

The instrument has several memories which are available for diagnosis purposes. The data remain even with voltage interruption.

Measured value memory

Up to 100,000 measured values can be stored in the sensor in a ring memory. Each entry contains date/time as well as the respective measured value. Storable values are for example:

- Distance
- Filling height
- Percentage value
- Lin. percent
- Scaled
- Current value
- Meas. reliability
- Electronics temperature

When the instrument is shipped, the measured value memory is active and stores distance, measurement certainty and electronics temperature every 3 minutes.

In "Extended adjustment" you can select the respective measured values.

The requested values and recording conditions are set via a PC with PACTware/DTM or the control system with EDD. Data are thus read out and also reset.

Event memory

Up to 500 events are automatically stored with a time stamp in the sensor (non-deletable). Each entry contains date/time, event type, event description and value. Event types are for example:

- Modification of a parameter
- Switch-on and switch-off times
- Status messages (according to NE 107)
- Error messages (according to NE 107)

The data are read out via a PC with PACTware/DTM or the control system with EDD.

Echo curve memory

The echo curves are stored with date and time and the corresponding echo data. The memory is divided into two sections:

Echo curve of the setup: This is used as reference echo curve for the measurement conditions during setup. Changes in the measurement conditions during operation or buildup on the sensor can thus be recognized. The echo curve of the setup is stored via:

- PC with PACTware/DTM
- Control system with EDD

- Display and adjustment module

Further echo curves: Up to 10 echo curves can be stored in a ring buffer in this memory section. Further echo curves are stored via:

- PC with PACTware/DTM
- Control system with EDD
- Display and adjustment module

9.3 Status messages

The instrument features self-monitoring and diagnostics according to NE 107 and VDI/VDE 2650. In addition to the status messages in the following tables there are more detailed error messages available under the menu item "*Diagnostics*" via the display and adjustment module, PACTware/DTM and EDD.

Status messages

The status messages are divided into the following categories:

- Failure
- Function check
- Out of specification
- Maintenance requirement

and explained by pictographs:

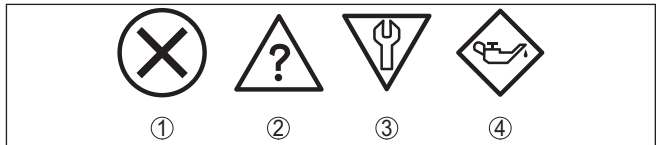

Fig. 22: Pictographs of the status messages

- 1 Failure - red
- 2 Out of specification - yellow
- 3 Function check - orange
- 4 Maintenance - blue

Failure: Due to a malfunction in the instrument, a failure message is outputted.

This status message is always active. It cannot be deactivated by the user.

Function check: The instrument is in operation, the measured value is temporarily invalid (for example during simulation).

This status message is inactive by default. It can be activated by the user via PACTware/DTM or EDD.

Out of specification: The measured value is unstable because the instrument specification is exceeded (e.g. electronics temperature).

This status message is inactive by default. It can be activated by the user via PACTware/DTM or EDD.

Maintenance: Due to external influences, the instrument function is limited. The measurement is affected, but the measured value is still valid. Plan in maintenance for the instrument because a failure is expected in the near future (e.g. due to buildup).

This status message is inactive by default. It can be activated by the user via PACTware/DTM or EDD.

Failure

The following table shows the error codes in the status message "Failure" and gives information on the reason and rectification. Keep in mind that some information is only valid with four-wire instruments.

| Code Text message | Cause | Rectification |
|---|---|---|
| F013 no measured value available | <ul style="list-style-type: none"> - Sensor does not detect an echo during operation - Process component or probe contaminated or defective | <ul style="list-style-type: none"> - Check or correct installation and/or parameter adjustment - Clean or exchange process component or probe |
| F017 Adjustment span too small | <ul style="list-style-type: none"> - Adjustment not within specification | <ul style="list-style-type: none"> - Change adjustment according to the limit values (difference between min. and max. ≥ 10 mm) |
| F025 Error in the linearization table | <ul style="list-style-type: none"> - Index markers are not continuously rising, for example unlogical value pairs | <ul style="list-style-type: none"> - Check values of the linearization table - Delete/create a new linearization table |
| F036 No operable software | <ul style="list-style-type: none"> - Failed or interrupted software update | <ul style="list-style-type: none"> - Repeat software update - Check electronics version - Exchanging the electronics - Send instrument for repair |
| F040 Error in the electronics | <ul style="list-style-type: none"> - Hardware defect | <ul style="list-style-type: none"> - Exchanging the electronics - Send instrument for repair |
| F041 Probe loss | <ul style="list-style-type: none"> - Cable probe broken or rod probe defective | <ul style="list-style-type: none"> - Check probe and exchange, if necessary |
| F080 General software error | <ul style="list-style-type: none"> - General software error | <ul style="list-style-type: none"> - Separate operating voltage briefly |
| F105 Measured value is determined | <ul style="list-style-type: none"> - The instrument is still in the start phase, the measured value could not yet be determined | <ul style="list-style-type: none"> - Wait for the end of the switch-on phase - Duration depending on the version and parameter adjustment max. 5 min. |
| F113 Communication error | <ul style="list-style-type: none"> - EMC interferences - Transmission error with the external communication with 4-wire power supply unit | <ul style="list-style-type: none"> - Remove EMC influences - Exchange 4-wire power supply unit or electronics |
| F125 Unpermissible electronics temperature | <ul style="list-style-type: none"> - Temperature of the electronics in the non-specified section | <ul style="list-style-type: none"> - Check ambient temperature - Isolate electronics - Use instrument with higher temperature range |

| Code Text message | Cause | Rectification |
|--|--|---|
| F260 Error in the calibration | <ul style="list-style-type: none"> - Error in the calibration carried out in the factory - Error in the EEPROM | <ul style="list-style-type: none"> - Exchanging the electronics - Send instrument for repair |
| F261 Error in the instrument settings | <ul style="list-style-type: none"> - Error during setup - Error when carrying out a reset - False signal suppression faulty | <ul style="list-style-type: none"> - Carry out a reset - Repeat setup |
| F264 Installation/ Setup error | <ul style="list-style-type: none"> - Error during setup | <ul style="list-style-type: none"> - Check or correct installation and/or parameter adjustment - Check probe length |
| F265 Measurement function disturbed | <ul style="list-style-type: none"> - Sensor no longer carries out a measurement | <ul style="list-style-type: none"> - Carry out a reset - Separate operating voltage briefly |
| F266 Impermissible operating voltage | <ul style="list-style-type: none"> - Operating voltage below specified range | <ul style="list-style-type: none"> - Check electrical connection - if necessary, increase operating voltage |
| F267 No executable sensor software | <ul style="list-style-type: none"> - Sensor cannot start | <ul style="list-style-type: none"> - Exchanging the electronics - Send instrument for repair |

Function check

The following table shows the error codes and text messages in the status message "*Function check*" and provides information on causes as well as corrective measures.

| Code Text message | Cause | Rectification |
|------------------------------------|--|--|
| C700 Simulation active | <ul style="list-style-type: none"> - A simulation is active | <ul style="list-style-type: none"> - Finish simulation - Wait for the automatic end after 60 mins. |

Out of specification

The following table shows the error codes and text messages in the status message "*Out of specification*" and provides information on causes as well as corrective measures.

| Code Text message | Cause | Rectification |
|---|---|--|
| S600 Unpermissible electronics temperature | <ul style="list-style-type: none"> - Temperature of the electronics in the non-specified section | <ul style="list-style-type: none"> - Check ambient temperature - Isolate electronics - Use instrument with higher temperature range |

| Code Text message | Cause | Rectification |
|------------------------------------|--------------------------------|---|
| S601 Overfilling | – Danger of vessel overfilling | – Make sure that there is no further filling – Check level in the vessel |

Maintenance

The following table shows the error codes and text messages in the status message "*Maintenance*" and provides information on causes as well as corrective measures.

| Code Text message | Cause | Rectification |
|---|---|---|
| M500 Error with the reset delivery status | – With the reset to delivery status, the data could not be restored | – Repeat reset – Load XML file with sensor data into the sensor |
| M501 Error in the non-active linearization table | – Hardware error EEPROM | – Exchanging the electronics – Send instrument for repair |
| M502 Error in the diagnosis memory | – Hardware error EEPROM | – Exchanging the electronics – Send instrument for repair |
| M503 Reliability too low | – The echot/noise ratio is the small for a reliable measurement | – Check installation and process conditions – Clean the antenna – Change polarisation direction – Use instrument with higher sensitivity |
| M504 Error on an device interface | – Hardware defect | – Check connections – Exchanging the electronics – Send instrument for repair |
| M505 No echo available | – Level echo can no longer be detected | – Clean the antenna – Use a more suitable antenna/sensor – Remove possible false echoes – Optimize sensor position and orientation |

9.4 Rectify faults

The operator of the system is responsible for taking suitable measures to rectify faults.

The first measures are:

Reaction when malfunctions occur

Procedure for fault rectification

- Evaluation of fault messages, for example via the display and adjustment module
- Checking the output signal
- Treatment of measurement errors

A PC with the software PACTware and the suitable DTM or the software PDM with a suitable DD offer further comprehensive diagnostics options. In many cases, the reasons can be determined in this way and faults can be rectified.

Check the 4 ... 20 mA signal

Connect a multimeter in the suitable measuring range according to the wiring plan. The following table describes possible errors in the current signal and helps to remove them:

| Error | Cause | Rectification |
|---|---|---|
| 4 ... 20 mA signal not stable | – Level fluctuations | – Set damping according to the instrument via the display and adjustment module or PACTware/DTM |
| 4 ... 20 mA signal missing | – Electrical connection faulty | – Check connection according to chapter "Connection steps" and if necessary, correct according to chapter "Wiring plan" |
| | – Voltage supply missing | – Check cables for breaks; repair if necessary |
| | – Operating voltage too low or load resistance too high | – Check, adapt if necessary |
| Current signal greater than 22 mA or less than 3.6 mA | – Electronics module in the sensor defective | – Exchange the instrument or send it in for repair |

Treatment of measurement errors

The below tables show typical examples for application-relevant measurement errors. There are two measurement errors:

- Constant level
- Filling
- Emptying

The images in column "Error pattern" show the real level with a broken line and the level displayed by the sensor as a continuous line.

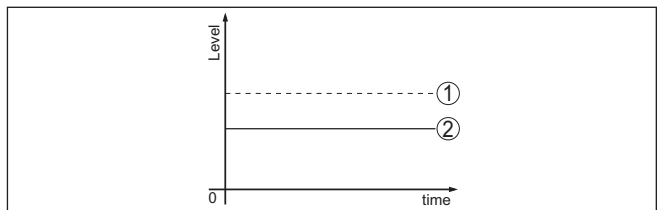

Fig. 23: The broken line 1 shows the real level, the continuous line 2 shows the level displayed by the sensor



Note:

- Wherever the sensor displays a constant value, the reason could also be the fault setting of the current output to "Hold value"
- In case of a too low level indication, the reason could be a line resistance that is too high



Measurement error with constant level

| Fault description | Error pattern | Cause | Rectification |
|---|---------------|---|---|
| 1. Measured value shows a too low or too high level | | - Min./max. adjustment not correct | - Adapt min./max. adjustment |
| | | - Wrong linearization curve | - Adapt linearization curve |
| | | - Running time error (small measurement error close to 100 %/serious error close to 0 %) | - Repeat setup |
| 2. Measured value jumps towards 100 % | | - Due to the process, the amplitude of the product echo sinks - A false signal suppression was not carried out | - Carry out a false signal suppression |
| | | - Amplitude or position of a false signal has changed (e.g. buildup); false signal suppression no longer matches | - Determine the reason for the changed false signals, carry out false signal suppression, e.g. with buildup |

Measurement error during filling

| Fault description | Error pattern | Cause | Rectification |
|--|---------------|--|---|
| 3. Measured value remains in the area of the bottom during filling | | - Echo from the probe end larger than the product echo, for example, with products with $\epsilon_r < 2.5$ oil-based, solvents, etc. | - Check parameter "Medium" and "Vessel height", adapt if necessary |
| 4. Measured value remains momentarily unchanged during filling and then jumps to the correct level | | - Turbulence on the product surface, quick filling | - Check parameters, change if necessary, e.g. in dosing vessel, reactor |
| 5. Measured value jumps sporadically to 100 % during filling | | - Changing condensation or contamination on the probe | - Carry out a false signal suppression |
| 6. Measured value jumps to $\geq 100\%$ or 0 m distance | | - Level echo is no longer detected in the close range due to false signals in the close range. The sensor goes into overflow protection mode. The max. level (0 m distance) as well as the status message "Overflow protection" are outputted. | - Eliminate false signals in the close range - Check installation conditions - If possible, switch off the function "Overflow protection" |

Measurement error during emptying

| Fault description | Error pattern | Cause | Rectification |
|--|---|---|--|
| 7. Measured value remains unchanged in the close range during emptying |  | <ul style="list-style-type: none"> - False echo larger than the level echo - Level echo too small | <ul style="list-style-type: none"> - Eliminate false signals in the close range - Remove contamination on the probe. After having removed the source of the false signals, the false signal suppression must be deleted. - Carry out a new false signal suppression |
| 8. Measured value remains reproducible in one position during emptying |  | <ul style="list-style-type: none"> - Stored false signals in this position are larger than the level echo | <ul style="list-style-type: none"> - Delete false signal memory - Carry out a new false signal suppression |

Reaction after fault rectification

Depending on the reason for the fault and the measures taken, the steps described in chapter "Setup" must be carried out again or must be checked for plausibility and completeness.

9.5 Exchanging the electronics module

If the electronics module is defective, it can be replaced by the user.



In Ex applications only one instrument and one electronics module with respective Ex approval may be used.

If there is no electronics module available on site, the electronics module can be ordered through the agency serving you. The electronics modules are adapted to the respective sensor and differ in signal output or voltage supply.

The new electronics module must be loaded with the default settings of the sensor. These are the options:

- In the factory
- Or on site by the user

In both cases, the serial number of the sensor is needed. The serial numbers are stated on the type label of the instrument, on the inside of the housing as well as on the delivery note.

When loading on site, first of all the order data must be downloaded from the Internet (see operating instructions manual "*Electronics module*").

9.6 Software update

The following components are required to update the sensor software:

- Sensor
- Voltage supply
- HART modem
- PC with PACTware
- Current sensor software as file

You can find the actual sensor software as well as detailed information of the procedure in the download area on our homepage: www.siemens.com.

You can find information about the installation in the download file.



Caution:

Instruments with approvals can be bound to certain software versions. Therefore make sure that the approval remains effective with a software update.

You can find detailed information in the download area on our homepage: www.siemens.com.

9.7 How to proceed in case of repair

If it is necessary to repair the instrument, please contact Siemens Milltronics Process Instruments. You find the locations on our homepage "www.siemens.com/processautomation".

10 Dismounting

10.1 Dismounting steps



Warning:

Before dismounting, be aware of dangerous process conditions such as e.g. pressure in the vessel, high temperatures, corrosive or toxic products etc.

Take note of chapters "*Mounting*" and "*Connecting to power supply*" and carry out the listed steps in reverse order.

10.2 Disposal

The instrument consists of materials which can be recycled by specialised recycling companies. We use recyclable materials and have designed the parts to be easily separable.

Correct disposal avoids negative effects on humans and the environment and ensures recycling of useful raw materials.

Materials: see chapter "*Technical data*"

If you have no way to dispose of the old instrument properly, please contact us concerning return and disposal.

WEEE directive 2002/96/EG

This instrument is not subject to the WEEE directive 2002/96/EG and the respective national laws. Pass the instrument directly on to a specialised recycling company and do not use the municipal collecting points. These may be used only for privately used products according to the WEEE directive.

11 Supplement

11.1 Technical data

General data

316L corresponds to 1.4404 or 1.4435

Materials, wetted parts

- Process fitting PTFE
- Process seal PTFE
- Rod: \varnothing 10 mm (0.394 in) - PFA coated 316L or Hastelloy C22 (2.4602)
- Cable: \varnothing 4 mm (0.157 in) - PFA coated 316 (1.4401)
- Gravity weight PFA coated

Materials, non-wetted parts

- Plastic housing plastic PBT (Polyester)
- Aluminium die-casting housing Aluminium die-casting AlSi10Mg, powder-coated - basis: Polyester
- Stainless steel housing - precision casting 316L
- Stainless steel housing, electropolished 316L
- Seal between housing and housing cover NBR (stainless steel housing, precision casting), silicone (aluminium/plastic housing; stainless steel housing, electropolished)
- Inspection window in housing cover (optional) Polycarbonate (with Ex d version: glass)
- Ground terminal 316L

Process fittings

- Clamp from 2"
- Bolting from DN 32 PN 40
- Flanges e.g. DIN from DN 25, ANSI from 2"

Weight

- Instrument weight (depending on process fitting) approx. 0.8 ... 8 kg (0.176 ... 17.64 lbs)
- Rod: \varnothing 10 mm (0.394 in) - PFA coated approx. 330 g/m (3.55 oz/ft)
- Cable: \varnothing 4 mm (0.157 in) - PFA coated approx. 41 g/m (0.44 oz/ft)
- Gravity weight (long) for cable \varnothing 4 mm (0.157 in) 325 g (11.5 oz)

Probe length L (from seal surface)

- Rod: \varnothing 10 mm (0.394 in) - PFA coated up to 4 m (13.12 ft)
- Trimming accuracy - rod ± 1 mm
- Cable: \varnothing 4 mm (0.157 in) - PFA coated up to 32 m (105 ft)
- Trimming accuracy - cable ± 0.05 %

Lateral load with rod: \varnothing 10 mm (0.394 in) - PFA coated 4 Nm (3 lbf ft)

Max. tensile load with cable: \varnothing 4 mm 2 KN (450 lbf)
 (0.157 in) - PFA coated

Torque for NPT cable glands and Conduit tubes

- Plastic housing max. 10 Nm (7.376 lbf ft)
- Aluminium/Stainless steel housing max. 50 Nm (36.88 lbf ft)

Input variable

Measured variable Level of liquids

Min. dielectric constant of the medium

- Cable probes $\epsilon_r \geq 1.6$
- Rod probes $\epsilon_r \geq 1.6$

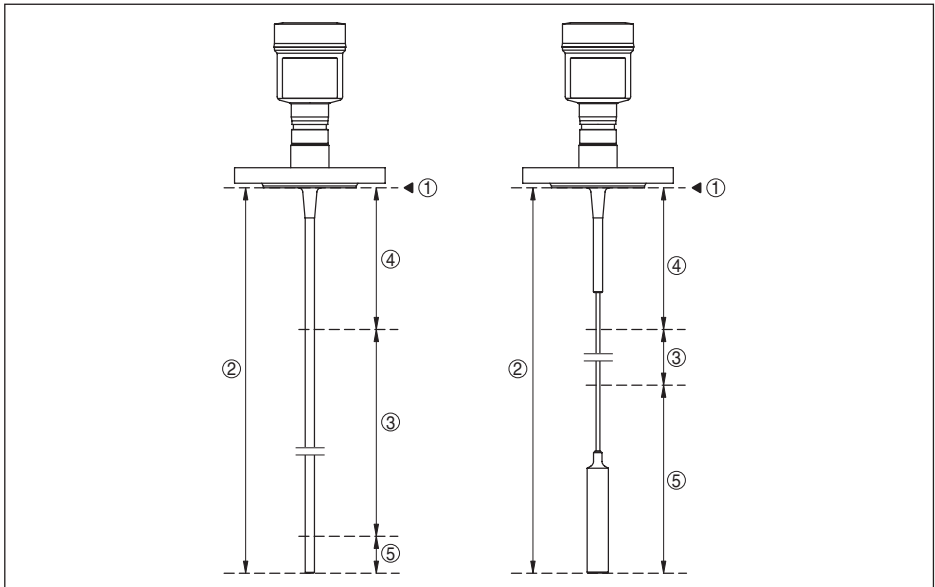

Fig. 32: Measuring ranges - SITRANS LG240

- 1 Reference plane
- 2 Probe length L
- 3 Measuring range (default setting refers to the measuring range in water)
- 4 Upper dead band (see diagrams under Accuracy - grey section)
- 5 Lower dead band (see diagrams under Accuracy - grey section)

Output variable

| | |
|----------------------------|---|
| Output signals | 4 ... 20 mA/HART - active; 4 ... 20 mA/HART - passive |
| Range of the output signal | 3.8 ... 20.5 mA/HART (default setting) |
| Terminal voltage passive | 9 ... 30 V DC |
| Shortcircuit protection | Available |
| Potential separation | Available |
| Signal resolution | 0.3 μ A |

| | |
|--|---|
| Failure signal current output (adjustable) | Last valid measured value, $\geq 21.0 \text{ mA}$, $\leq 3.6 \text{ mA}$ |
| Max. output current | 21 mA |
| Starting current | $\leq 3.6 \text{ mA}$ |
| Load (4 ... 20 mA/HART - active) | $< 500 \Omega$ |
| Damping (63 % of the input variable) | 0 ... 999 s, adjustable |
| HART output values according to HART 7 (default setting) ¹⁾ | |
| – First HART value (PV) | Linearised percentage value, level |
| – Second HART value (SV) | Distance to the level |
| – Third HART value (TV) | Measurement certainty, level |
| – Fourth HART value (QV) | Electronics temperature |
| Indication value - Display and adjustment module ²⁾ | |
| – Displayed value 1 | Filling height - Level |
| – Displayed value 2 | Electronics temperature |
| Resolution, digital | $< 1 \text{ mm}$ (0.039 in) |

Accuracy (according to DIN EN 60770-1)

Process reference conditions according to DIN EN 61298-1

| | |
|---------------------|--|
| – Temperature | +18 ... +30 °C (+64 ... +86 °F) |
| – Relative humidity | 45 ... 75 % |
| – Air pressure | +860 ... +1060 mbar/+86 ... +106 kPa (+12.5 ... +15.4 psig) |

Installation reference conditions

| | |
|----------------------------------|---|
| – Min. distance to installations | $> 500 \text{ mm}$ (19.69 in) |
| – Vessel | metallic, $\varnothing 1 \text{ m}$ (3.281 ft), centric installation, process fitting flush with the vessel ceiling |
| – Medium | Water/Oil (dielectric constant ~ 2.0) ³⁾ |
| – Installation | Probe end does not touch the vessel bottom |

Sensor parameter adjustment No gating out of false signals carried out

Typical deviation - Interface measurement $\pm 5 \text{ mm}$ (0.197 in)

Typical deviation - Total level interface measurement See following diagrams

Typical deviation - Level measurement⁴⁾⁵⁾ See following diagrams

¹⁾ The output values can be assigned individually

²⁾ The indication values can be assigned individually

³⁾ With interface measurement = 2.0

⁴⁾ Depending on the installation conditions, there can be deviations which can be rectified with an adaptation of the adjustment or a change of the measured value offset in the DTM service mode

⁵⁾ The dead bands can be optimized by a false signal suppression.

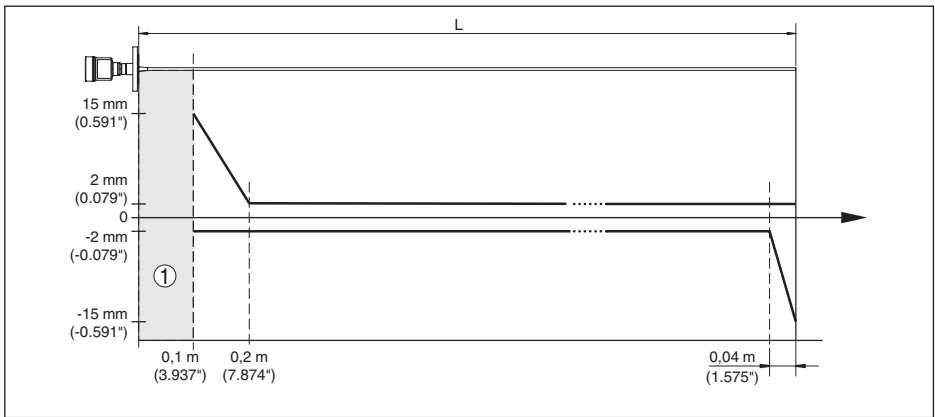

Fig. 33: Deviation SITRANS LG240 in rod version (coated) in water

1 Dead band - no measurement possible in this area

L Probe length

Deviation - level measurement from 6 m 0.5 % of the probe length
probe length

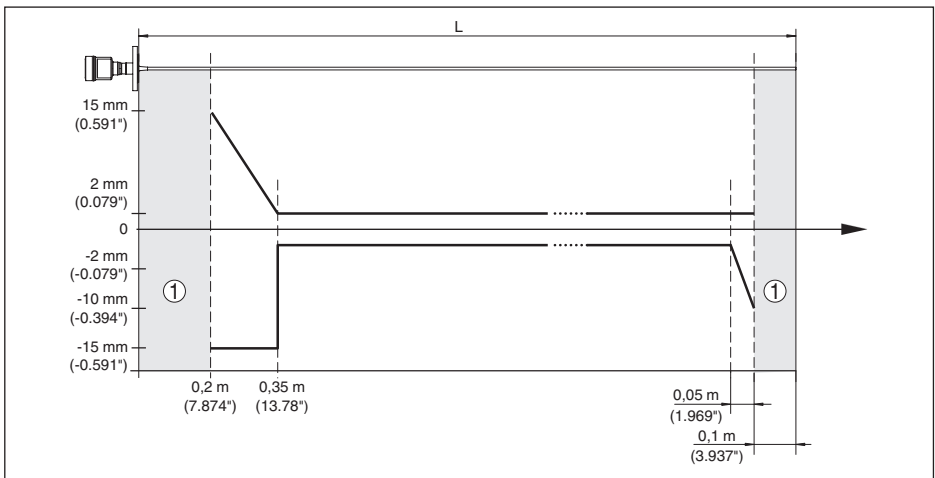

Fig. 34: Deviation SITRANS LG240 in rod version (coated) in oil

1 Dead band - no measurement possible in this area

L Probe length

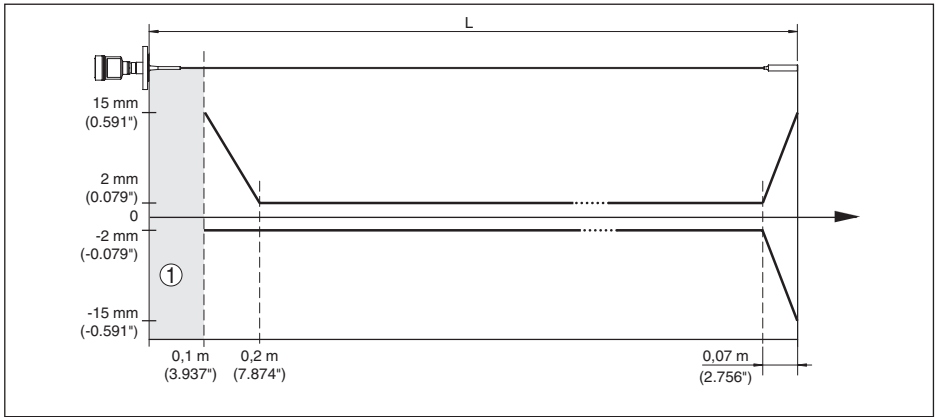

Fig. 35: Deviation SITRANS LG240 in cable version (coated) in water

- 1 Dead band - no measurement possible in this area
- L Probe length

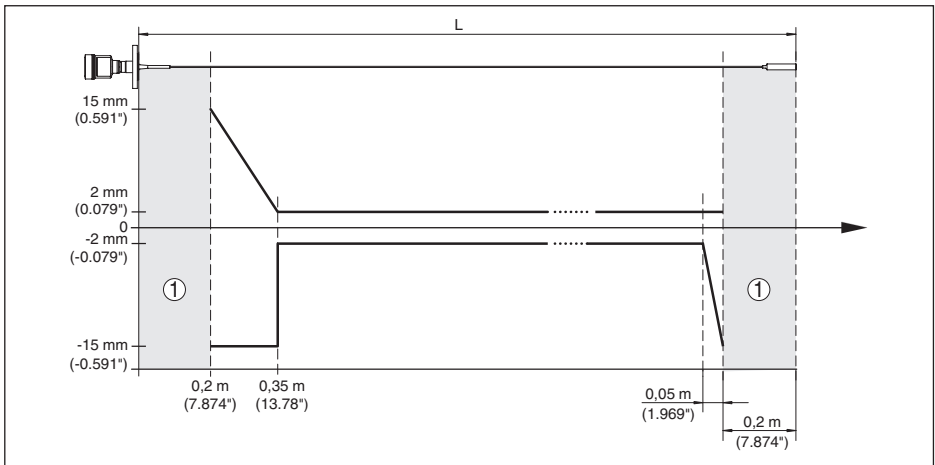

Fig. 36: Deviation SITRANS LG240 in cable version (coated) in oil

- 1 Dead band - no measurement possible in this area
- L Probe length

Repeatability $\leq \pm 1$ mm

Variables influencing measurement accuracy

Specifications for the digital measured value

| | |
|--|---|
| Temperature drift - Digital output | ± 3 mm/10 K relating to the max. measuring range or max. 10 mm (0.394 in) |
| Additional deviation through electromagnetic interference acc. to EN 61326 | $< \pm 10$ mm ($< \pm 0.394$ in) |

Specifications apply also to the current output⁶⁾

Temperature drift - Current output $\pm 0.03\%$ /10 K relating to the 16 mA span max. $\pm 0.3\%$

Deviation on the current output through analogue/digital conversion $< \pm 15\ \mu\text{A}$

Additional deviation through electromagnetic interference acc. to EN 61326 $< \pm 150\ \mu\text{A}$

Influence of the superimposed gas and pressure to the accuracy

The propagation speed of the radar impulses in gas or vapour above the medium is reduced by high pressure. This effect depends on the superimposed gas or vapour and is especially large at low temperatures.

The following table shows the resulting deviation for some typical gases and vapours. The specified values refer to the distance. Positive values mean that the measured distance is too large, negative values that the measured distance is too small.

| Gas phase | Temperature | Pressure | | |
|-------------------------|---------------|-------------------|-------------------|-------------------|
| | | 1 bar (14.5 psig) | 10 bar (145 psig) | 50 bar (725 psig) |
| Air | 20 °C/68 °F | 0.00 % | 0.22 % | 1.2 % |
| | 200 °C/392 °F | -0.01 % | 0.13 % | 0.74 % |
| | 400 °C/752 °F | -0.02 % | 0.08 % | 0.52 % |
| Hydrogen | 20 °C/68 °F | -0.01 % | 0.10 % | 0.61 % |
| | 200 °C/392 °F | -0.02 % | 0.05 % | 0.37 % |
| | 400 °C/752 °F | -0.02 % | 0.03 % | 0.25 % |
| Steam (saturated steam) | 100 °C/212 °F | 0.26 % | - | - |
| | 180 °C/356 °F | 0.17 % | 2.1 % | - |
| | 264 °C/507 °F | 0.12 % | 1.44 % | 9.2 % |
| | 366 °C/691 °F | 0.07 % | 1.01 % | 5.7 % |

Characteristics and performance data

Measuring cycle time $< 500\ \text{ms}$

Step response time⁷⁾ $\leq 3\ \text{s}$

Max. filling/emptying speed $1\ \text{m/min}$

Ambient conditions

Ambient, storage and transport temperature- $-40 \dots +80\ \text{°C}$ ($-40 \dots +176\ \text{°F}$)
ture

Process conditions

For the process conditions, please also note the specifications on the type label. The lowest value always applies.

The measurement error from the process conditions is in the specified pressure and temperature range of below 1 %.

⁶⁾ Also for the second current output (optional)

⁷⁾ Time span after a sudden measuring distance change by max. 0.5 m in liquid applications, max 2 m with bulk solids applications, until the output signal has taken for the first time 90 % of the final value (IEC 61298-2).

Process pressure

- Clamp, flange version $\leq 2''/DN\ 50$ -0.5 ... +16 bar/-50 ... +1600 kPa (-7.3 ... +232 psig), depending on the process fitting
- Clamp, flange version $> 2''/DN\ 50$ -0.2 ... +16 bar/-20 ... +1600 kPa (-2.9 ... +232 psig), depending on the process fitting

Vessel pressure relating to the flange nominal stage

see supplementary instructions manual "*Flanges according to DIN-EN-ASME-JIS*"

Process temperature (thread or flange temperature)

- FKM (SHS FPM 70C3 GLT) -40 ... +150 °C (-40 ... +302 °F)
- EPDM (A+P 75.5/KW75F) -40 ... +150 °C (-40 ... +302 °F)

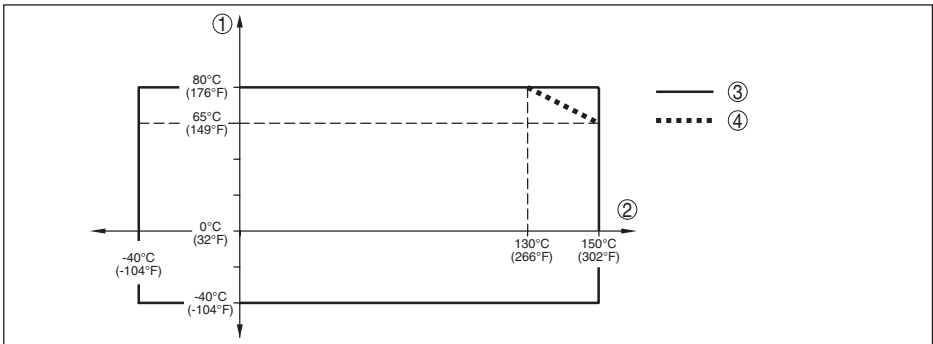

Fig. 37: Ambient temperature - process temperature, standard version

- 1 Ambient temperature
- 2 Process temperature (depending on the seal material)
- 3 Maximum permissible temperature - standard
- 4 Limited temperature range - plastic housing and stainless steel housing, electropolished

Vibration resistance

- Instrument housing 4 g at 5 ... 200 Hz according to EN 60068-2-6 (vibration with resonance)
- Rod probe 1 g with 5 ... 200 Hz according EN 60068-2-6 (vibration at resonance) with rod length 50 cm (19.69 in)

Shock resistance

- Instrument housing 100 g, 6 ms according to EN 60068-2-27 (mechanical shock)
- Rod probe 25 g, 6 ms according to EN 60068-2-27 (mechanical shock) with rod length 50 cm (19.69 in)

Electromechanical data - version IP 66/IP 67

Options of the cable entry

- Cable gland M20 x 1.5
- Cable diameter (options) 5 ... 9 mm (0.20 ... 0.35 in)
6 ... 12 mm (0.24 ... 0.47 in)
10 ... 14 mm (0.39 ... 0.55 in)

44287-EN-131001

| | |
|---------------|------------------|
| – Cable entry | ½ NPT |
| – Blind plug | M20 x 1.5; ½ NPT |

Plug options

| | |
|---|--------------|
| – Supply and signal circuit (only with low voltage) | M12 x 1 plug |
| – Indication circuit | M12 x 1 plug |

Wire cross-section (spring-loaded terminals)

| | |
|---------------------------------|---|
| – Massive wire, cord | 0.2 ... 2.5 mm ² (AWG 24 ... 14) |
| – Stranded wire with end sleeve | 0.2 ... 1.5 mm ² (AWG 24 ... 16) |

Display and adjustment module

| | |
|-----------------|------------------------|
| Display element | Display with backlight |
|-----------------|------------------------|

Measured value indication

| | |
|--------------------|-------------------|
| – Number of digits | 5 |
| – Size of digits | W x H = 7 x 13 mm |

| | |
|---------------------|--------|
| Adjustment elements | 4 keys |
|---------------------|--------|

Protection rating

| | |
|--|-------|
| – unassembled | IP 20 |
| – mounted into the housing without cover | IP 40 |

Materials

| | |
|---------------------|----------------|
| – Housing | ABS |
| – Inspection window | Polyester foil |

Integrated clock

| | |
|-------------|----------------|
| Date format | Day.Month.Year |
|-------------|----------------|

| | |
|-------------|-----------|
| Time format | 12 h/24 h |
|-------------|-----------|

| | |
|----------------------|-----|
| Time zone Ex factory | CET |
|----------------------|-----|

Measurement electronics temperature

| | |
|------------|---------------|
| Resolution | 1 °C (1.8 °F) |
|------------|---------------|

| | |
|----------|----------------|
| Accuracy | ±1 °C (1.8 °F) |
|----------|----------------|

Voltage supply

Operating voltage

| | |
|-----------------------------|---|
| – Version for low voltage | 9.6 ... 48 V DC, 20 ... 42 V AC, 50/60 Hz |
| – Version for mains voltage | 90 ... 253 V AC, 50/60 Hz |

| | |
|--------------------------|------------|
| Interpolation protection | Integrated |
|--------------------------|------------|

| | |
|------------------------|-------------|
| Max. power consumption | 4 VA; 2.1 W |
|------------------------|-------------|

Electrical protective measures

| | |
|-------------------|-------------|
| Protection rating | IP 66/IP 67 |
|-------------------|-------------|

| | |
|-----------------------|-----|
| Oversvoltage category | III |
|-----------------------|-----|

Approvals

Instruments with approvals can have deviating technical data (depending on the version). For such instruments, the corresponding approval documents must be noted.

11.2 Dimensions

Housing

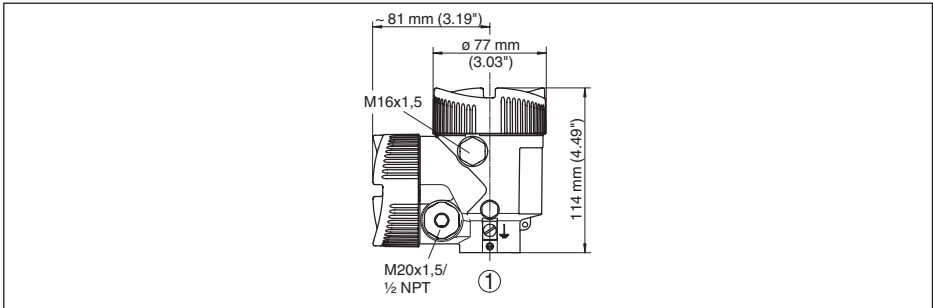

Fig. 38: Dimensions housing - with integrated display and adjustment module the housing is 9 mm/0.35 in higher

SITRANS LG240, cable version \varnothing 4 mm (0.157 in) - PFA coated

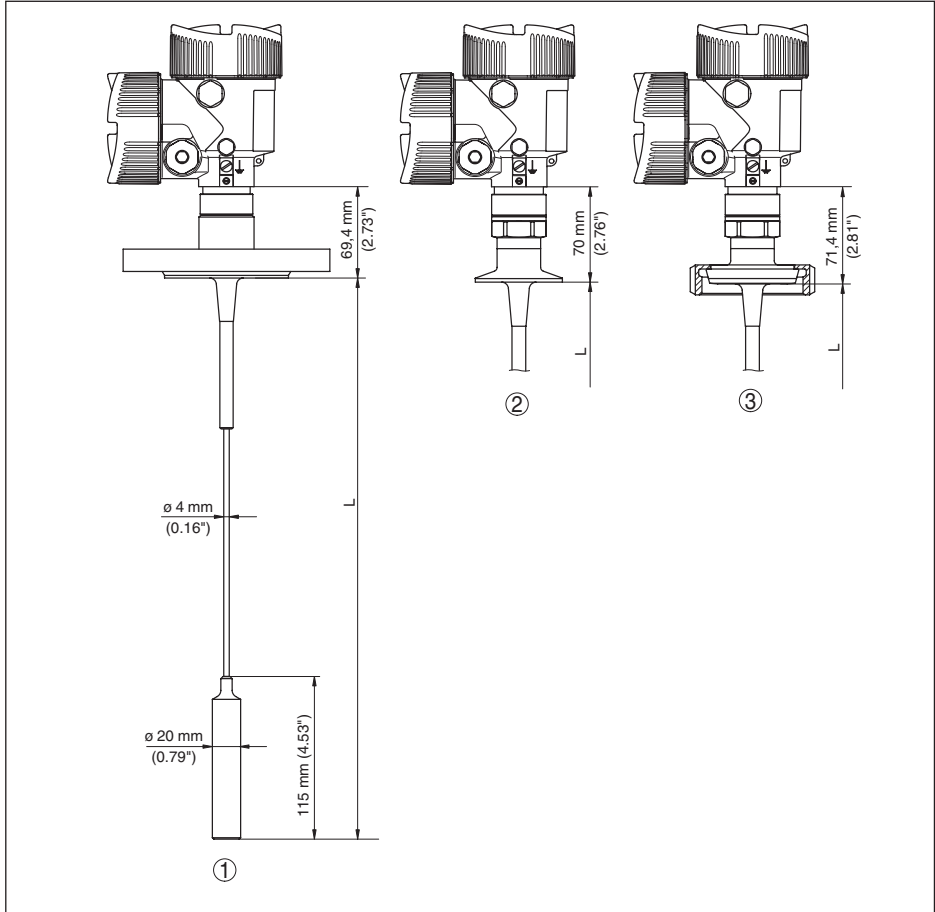

Fig. 39: SITRANS LG240, cable version with gravity weight

- L Sensor length, see chapter "Technical data"
- 1 Cable version, \varnothing 4 mm (0.157 in) with flange
- 2 Cable version with Clamp
- 3 Cable version with bolting

SITRANS LG240, rod version \varnothing 10 mm (0.394 in) - PFA coated

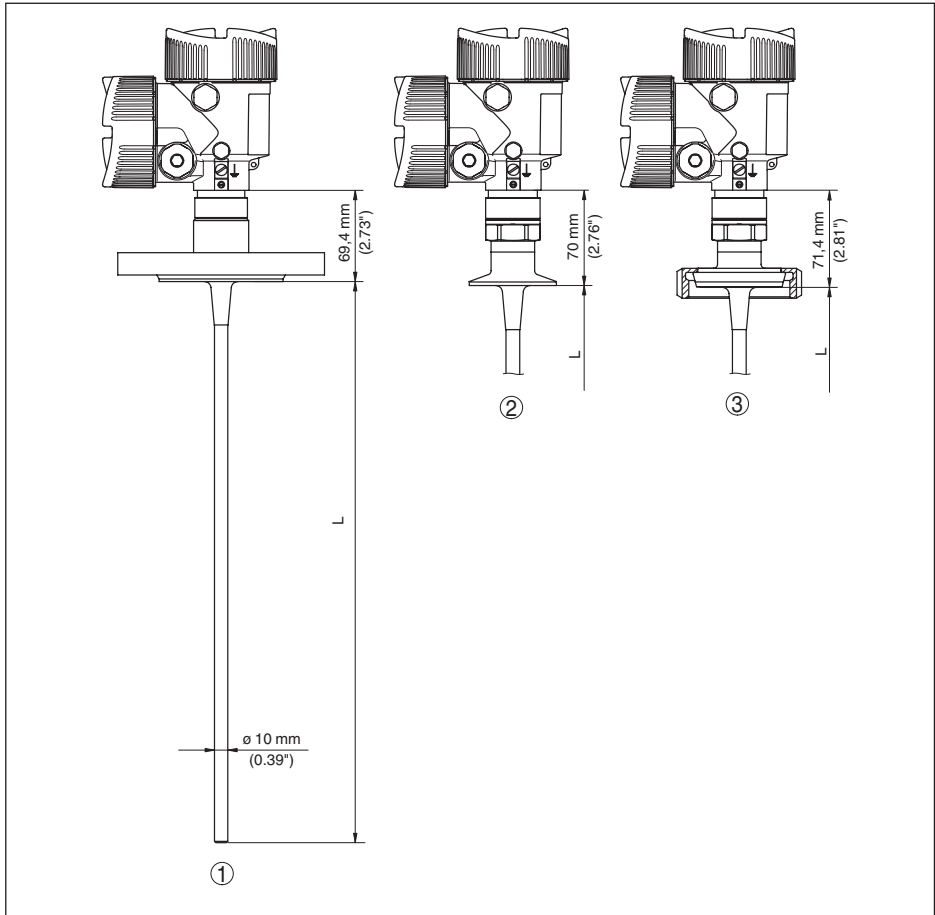

Fig. 40: SITRANS LG240, rod version

- L Sensor length, see chapter "Technical data"
- 1 Rod version, \varnothing 10 mm (0.394 in) with flange
- 2 Rod version with Clamp
- 3 Rod version with bolting

INDEX

A

Accessories

- Display and adjustment module 11
- External display and adjustment unit 12

Adjustment

- Max. adjustment 31, 32
- Min. adjustment 32, 33

Adjustment system 26

Application 30, 31

Application area 9

B

Backlight 39

Block adjustment 38

C

Cable entry 18

Check signal 62

Connection cable 18

Connection compartment

- Double chamber housing 21, 22

Connection procedure 19

Connection technology 19

Copy sensor settings 45

Current output, adjustment 36

Current output Min./Max. 37

Current output mode 36

Current output, size 36

Curve indication

- Echo curve 41

D

Damping 33

Date of manufacture 47

Date/Time 42

Default values 43

Deviation 62

E

Echo curve memory 57

Echo curve of the setup 42

EDD (Enhanced Device Description) 56

Electronics compartment, double chamber housing 21

Error messages 58

Event memory 57

F

Factory calibration date 47

False signal suppression 37

Fault rectification 61

Functional principle 9

G

Gas phase 31

Grounding 18

H

HART address 46

HART variables 37

I

Inflowing medium 15

Installation position 13

K

Key function 25

L

Language 39

Linearization 33

M

Main menu 29

Meas. reliability 40

Measured value indication 39

Measured value memory 57

Measurement loop name 29

Moisture 13

N

NAMUR NE 107

- Failure 59

- Function check 60

- Maintenance 61

- Out of specification 60

P

Packaging 11

Peak value 40

PIN 42

Potential equalisation 18

Probe length 30

Probe type 46

Protection class 18

Q

Quick setup 27

R

Read out info 47

Repair 65
Replacement parts
– Electronics module 12
– Spacer 12
Reset 43

S

Scaling measured value 35, 36
Sensor characteristics 47
Sensor status 40
Shielding 18
Simulation 41
Special parameters 46
Status messages 58
Storage 11

T

Type of medium 30
Type plate 8

U

Units 30

V

Voltage supply 18, 74

For more information

www.siemens.com/level

www.siemens.com/weighing

Siemens AG
Industry sector
1954 Technology Drive
P.O. Box 4225
Petersborough, ON
Canada K9J7B1

email: techpubs.smpi@siemens.com

www.siemens.com/processautomation

Subject to change without prior notice
PBD-51041039 Rev. 0.0

© Siemens AG 2013



PBD-51041039

Printed in Canada